



PV Inverter

SUNNY MINI CENTRAL 4600A / 5000A / 6000A

Installation Manual

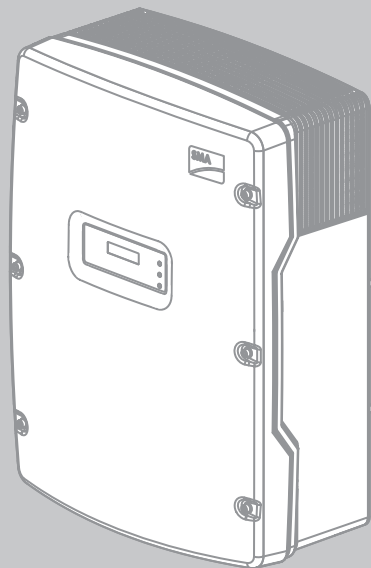

Table of Contents

1	Information on this Manual.	7
1.1	Validity	7
1.2	Target Group	7
1.3	Additional Information	7
1.4	Symbols Used	8
2	Safety	9
2.1	Intended Use.	9
2.2	Safety Precautions.	10
2.3	Explanation of Symbols	11
2.3.1	Symbols on the Inverter.	11
2.3.2	Symbols on the Type Label	12
3	Unpacking.	13
3.1	Scope of Delivery	13
3.2	Identifying the Inverter	14
4	Assembly.	15
4.1	Safety	15
4.2	Selecting the Mounting Location.	15
4.3	Mounting the Inverter using the Wall Mounting Bracket	17
5	Electrical Connection	20
5.1	Overview of the Connection Area	20
5.1.1	Exterior View	20
5.1.2	Interior View	21
5.2	Connection to the Electricity Grid (AC).	22
5.2.1	Conditions for the AC Connection	22
5.2.2	Connecting the Inverter to the Electricity Grid (AC)	24
5.2.3	Additional Earthing of the Enclosure	25

5.3	Setting the Display Language	26
5.4	Connecting the PV Array (DC)	27
5.4.1	Conditions for DC Connection	27
5.4.2	Assembling the DC Connectors.	28
5.4.3	Opening the DC Connector	30
5.4.4	Connecting the PV Array (DC)	31
5.5	Connecting the SMA Power Balancer	34
5.5.1	Configuration	34
5.5.2	Cabling	38
5.5.3	Function Test	41
5.6	Communication	42
5.7	Setting the Grid and Country Parameters	42
5.7.1	Setting the Installation Country	42
5.7.2	Setting the Stand-Alone Grid Operation	43
5.7.3	Additional Country Parameters	43
6	Commissioning	44
6.1	Commissioning the Inverter	44
6.2	Only for Italy: Self-Test in Accordance with CEI 0-21	45
6.2.1	Starting the Self-Test	45
6.2.2	Abortion of the Self-Test	46
6.2.3	Restarting the Self-Test.	46
6.3	Display Messages During the Start-up Phase	47
7	Opening and Closing.	48
7.1	Safety	48
7.2	Opening the Inverter.	48
7.3	Closing the Inverter.	51
8	Maintenance and Cleaning.	53
8.1	Cleaning the Inverter.	53
8.2	Checking Heat Dissipation	53

8.2.1	Cleaning the Fans	53
8.2.2	Checking the Fans	55
8.2.3	Cleaning the Ventilation Grids	56
8.3	Checking the Electronic Solar Switch (ESS) for Wear	57
9	Troubleshooting	58
9.1	Blink Codes	58
9.2	Error Messages	59
9.3	Red LED is Permanently Glowing	63
9.3.1	Checking the PV Array for Earth Faults	64
9.3.2	Checking the Function of the Varistors	66
10	Decommissioning	68
10.1	Dismounting the Inverter	68
10.2	Packing the Inverter	69
10.3	Storing the Inverter	69
10.4	Disposing of the Inverter	69
11	Technical Data	70
11.1	DC/AC	70
11.1.1	Sunny Mini Central 4600A	70
11.1.2	Sunny Mini Central 5000A	72
11.1.3	Sunny Mini Central 6000A	74
11.2	General Data	76
11.3	Protective Devices	76
11.4	Approvals	77
11.5	Climatic Conditions	77
11.6	Features	78
11.7	Electronic Solar Switch (ESS)	78
11.8	Torques	78
11.9	Earthing Systems	78

12	Accessories	79
13	Contact	80

1 Information on this Manual

1.1 Validity

This installation manual describes the assembly, installation, commissioning, maintenance and troubleshooting of the following SMA inverters:

- Sunny Mini Central 4600A (SMC 4600A, SMC 4600A-11)
- Sunny Mini Central 5000A (SMC 5000A, SMC 5000A-11)
- Sunny Mini Central 6000A (SMC 6000A, SMC 6000A-11)

Store this manual where it will be accessible at all times.

1.2 Target Group

This manual is for the use of electrically skilled persons. The tasks described in this manual must be performed by electrically skilled persons only.





1.3 Additional Information

You will find further information on special topics, such as the design of a miniature circuit-breaker or the description of the operating parameters, in the download area at www.SMA-Solar.com.

Refer to the user manual provided for detailed information on how to operate the inverter.

1.4 Symbols Used

The following types of safety precautions and general information are used in this manual:

	DANGER!
DANGER indicates a hazardous situation which, if not avoided, will result in death or serious injury.	
	WARNING!
WARNING indicates a hazardous situation which, if not avoided, can result in death or serious injury.	
	CAUTION!
CAUTION indicates a hazardous situation which, if not avoided, could result in minor or moderate injury.	
	NOTICE!
NOTICE indicates a situation which, if not avoided, could result in property damage.	
	Information
An Information block provides valuable hints for the efficient installation and operation of your product.	
<input checked="" type="checkbox"/>	This symbol indicates the result of an action.

2 Safety

2.1 Intended Use

The Sunny Mini Central is a PV inverter which converts the direct current of the PV array to alternating current and feeds it into the power distribution grid.

Principle of a PV plant with Sunny Mini Central

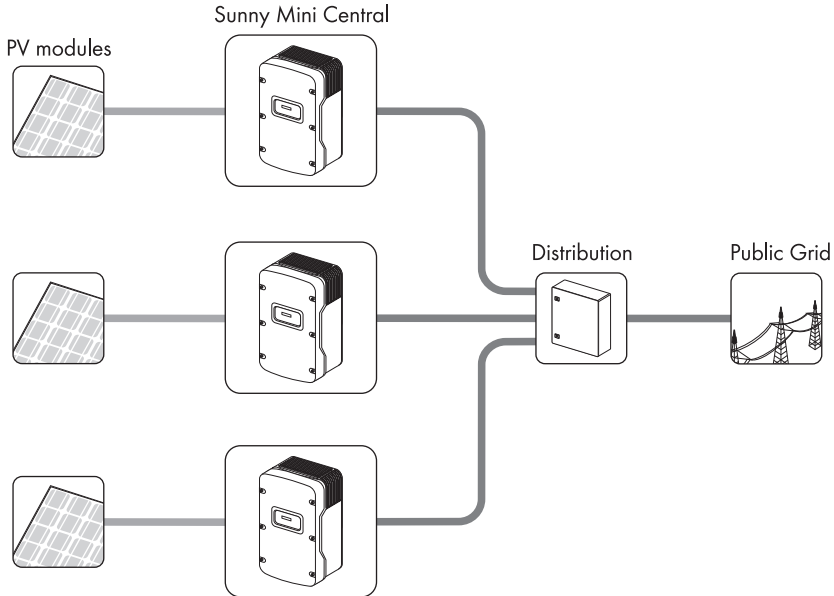

The Sunny Mini Central may only be operated with PV arrays (PV modules and cabling) of protection class II. Do not connect any energy sources other than PV modules to the Sunny Mini Central.

When designing the PV plant, ensure that the permitted operating range of all components is complied with at all times. The free design software "Sunny Design" (www.SMA-Solar.com) will assist you. The manufacturer of the PV modules must have approved the modules for use with this Sunny Mini Central. You must also ensure that all measures recommended by the module manufacturer for the long-term maintenance of the module properties are taken (see also Technical Information "Module Technology" at www.SMA-Solar.com).

For safety reasons, it is not permitted to modify the product or install components that are not explicitly recommended or distributed by SMA Solar Technology AG.

2.2 Safety Precautions

 **DANGER!**
Danger to life due to high voltages in the inverter

- All work on the inverter must be carried out by skilled persons only.

 **CAUTION!**
Risk of burns due to hot enclosure parts

- Do not touch the enclosure body during operation.
- Only touch the enclosure lid during operation.

 **NOTICE!**
Water- and dust intrusion can damage the inverter.

Once the Electronic Solar Switch has been pulled out, the inverter only provides protection rating IP21. The inverter is thus no longer protected against water- and dust intrusion. In order that the degree of protection IP65 is also maintained during temporary decommissioning, proceed as follows:

- Release and disconnect all DC connectors.
- Open all DC connectors and remove the cables.
- Close all DC inputs using the corresponding DC connectors and the supplied sealing plugs.
- Firmly re-connect the Electronic Solar Switch.

 **NOTICE!**
Damage to the inverter due to moisture and dust intrusion

If the Electronic Solar Switch is not plugged in or incorrectly plugged in during operation, moisture and dust can penetrate the inverter.

If the Electronic Solar Switch is not correctly plugged in, this can cause contacts to wear in the Electronic Solar Switch or the Electronic Solar Switch might fall out. This can result in yield loss and damage to the Electronic Solar Switch.

Always plug in the Electronic Solar Switch as described in the following:

- Do not tighten the screw in the Electronic Solar Switch.
- Firmly plug in the Electronic Solar Switch until it is flush with the enclosure.
- Ensure that the maximum distance between the Electronic Solar Switch and the enclosure is 1 mm.



Earthing of the PV array

Comply with the local regulations for earthing the modules and the PV array. In order to maintain the best possible protection for both the PV plant and human life, SMA Solar Technology AG recommends connecting together the PV array frame and other electrically conductive surfaces and earthing them.











2.3 Explanation of Symbols

This section gives an explanation of all the symbols found on the inverter and on the type label.

2.3.1 Symbols on the Inverter

Symbol	Explanation
	Operation display Indicates the operating state of the inverter
	Earth fault or varistor defective Read Section 9.3 "Red LED is Permanently Glowing" (page 63).
	Error or fault Read Section 9 "Troubleshooting" (page 58).
	You can operate the display by tapping the enclosure lid. <ul style="list-style-type: none"> • Tapping once: the backlight switches on or the display scrolls to the next display message. • Tapping twice in quick succession: The inverter shows the display messages from the start-up phase again (see Section 6.3 "Display Messages During the Start-up Phase" (page 47)).
	DC load disconnection unit Electronic Solar Switch (ESS) <ul style="list-style-type: none"> • ❶ When the Electronic Solar Switch is plugged in, the DC electric circuit is closed. • ❷ To interrupt the DC electric circuit and safely disconnect the inverter when under load, you must first remove the Electronic Solar Switch ❶ and then all DC connectors ❷.
	QR Code® for SMA bonus programme You will find information on the SMA bonus programme at www.SMA-Bonus.com .

2.3.2 Symbols on the Type Label

Symbol	Explanation
	Beware of hazardous voltage The inverter operates at high voltages. All work on the inverter must be carried out by skilled persons only.
	Beware of hot surface. The inverter can get hot during operation. Avoid contact during operation.
	Observe all documentation that accompanies the inverter.
	The inverter must not be disposed of together with the household waste. For more information on disposal, see Section 10.4 "Disposing of the Inverter" (page 69).
	CE marking The inverter complies with the requirements of the applicable EC directives.
	The inverter has a transformer.
	Direct current (DC)
	Alternating current (AC)
	Outdoor The product is suitable for outdoor installation.
IP65	Degree of protection: IP65 The inverter is protected against dust intrusion and water jets from any angle.
	RAL quality mark for solar products The inverter complies with the requirements of the German Institute for Quality Assurance and Labelling.

3 Unpacking

3.1 Scope of Delivery

Check the delivery for completeness and any visible external damage. Contact your specialist dealer if anything is damaged or missing.

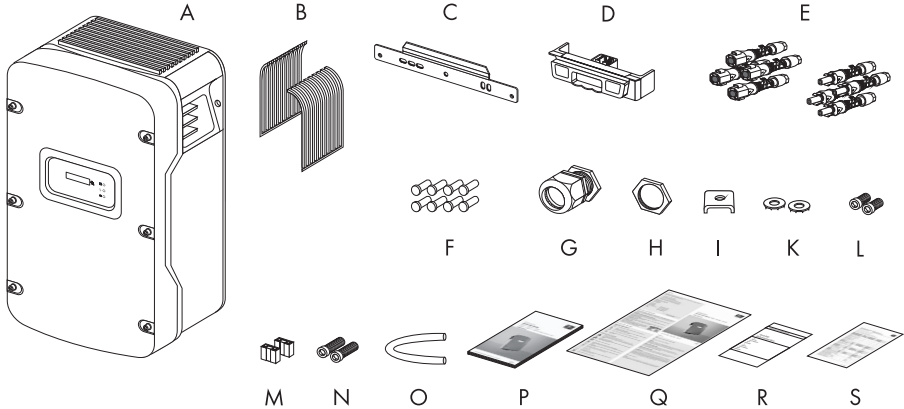

Object	Quantity	Description
A	1	Sunny Mini Central
B	1	Ventilation grid (right/left)
C	1	Wall mounting bracket
D	1	DC load disconnection unit Electronic Solar Switch (ESS)
E	8	DC connectors (4 x positive, 4 x negative)
F	8	Sealing plug for the DC connectors
G	1	Cable gland for AC connection
H	1	Counter nut for cable gland at AC connection
I	1	Clamping bracket for additional earthing
K	2	Conical spring washers: 1 x for enclosure lid screws (replacement), 1 x for earth terminal
L	2	Cheese-head screws (M6x16): 1 x for enclosure lid (replacement), 1 x for earth terminal
M	2	Jumpers (1 x for fan test, 1 x for the SMA Power Balancer wiring)
N	2	Cylinder head screws (M6x8) for securing the inverter to the wall mounting bracket
O	1	Silicone tube for insulating the SMA Power Balancer connection cable
P	1	Installation manual
Q	1	User manual

Object	Quantity	Description
R	1	Set of documents with explanations and certificates
S	1	Supplementary sheet with inverter default settings



3.2 Identifying the Inverter

You can identify the inverter by the type label. The type label is located on the right-hand side of the enclosure.

The inverter serial number (Serial No.), the type (Type/Model) and other device-specific characteristics are specified on the type label.

4 Assembly

4.1 Safety

 <p>DANGER! Danger to life due to fire or explosions</p>
<p>Despite careful construction, electrical devices can cause fires.</p> <ul style="list-style-type: none"> • Do not mount the inverter on flammable construction materials. • Do not mount the inverter in areas where highly flammable materials are stored. • Do not mount the inverter in a potentially explosive atmosphere.
 <p>CAUTION! Risk of burns due to hot enclosure parts</p>
<ul style="list-style-type: none"> • Mount the inverter in such a way that it cannot be touched inadvertently.
 <p>CAUTION! Risk of injury due to the heavy weight of the inverter</p>
<ul style="list-style-type: none"> • Take the inverter's weight of approx. 63 kg into account when mounting.

4.2 Selecting the Mounting Location

Take the following requirements into consideration when selecting the mounting location:

- The mounting method and location must be suitable for the inverter's weight and dimensions (see Section 11 "Technical Data" (page 70)).
- Mount on a solid surface.
- The mounting location must be clear and safely accessible at all times without the use of additional aids such as scaffolding or lifting platforms. If this is not the case, service work may be restricted.

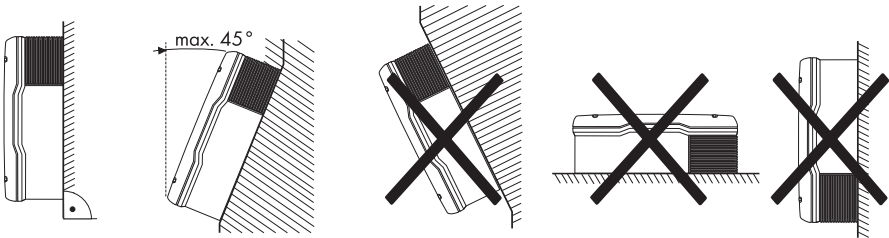

- Mount vertically or tilted backwards by max. 45°.
- The connection area must face downwards.

- Never mount the device with a forward tilt.
- Never mount the device with a sideways tilt.
- Do not mount horizontally.
- Mount at eye level in order that operating states can be read at all times.
- The ambient temperature should be below 40°C to ensure optimum operation.
- Do not expose the inverter to direct solar irradiation as this could cause power derating due to overheating.
- In order to avoid audible vibrations in living areas, do not mount the unit on plasterboard walls or similar. When in operation, the inverter emits noise which may be perceived as annoying in living areas.
- Observe the minimum clearances to walls, other inverters and objects as shown in the diagram in order to ensure sufficient heat dissipation and to have sufficient space for removing the Electronic Solar Switch.

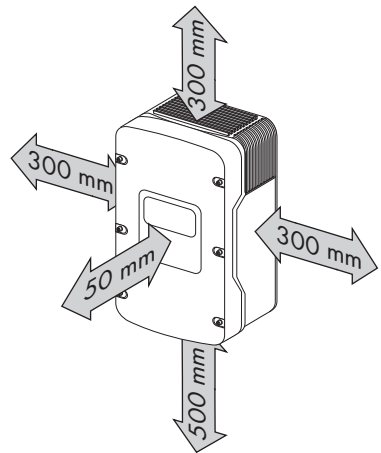

Multiple inverters installed in areas with high ambient temperatures

There must be sufficient clearance between the individual inverters to ensure that the cooling air of the adjacent inverter is not drawn in.

If necessary, increase the clearances and make sure there is enough fresh-air supply to ensure sufficient cooling of the inverters.

4.3 Mounting the Inverter using the Wall Mounting Bracket

1. Mark the position of the drill holes using the wall mounting bracket and drill the holes. Use at least 2 of the 6 holes, 1 hole on the left- and right-hand sides respectively.

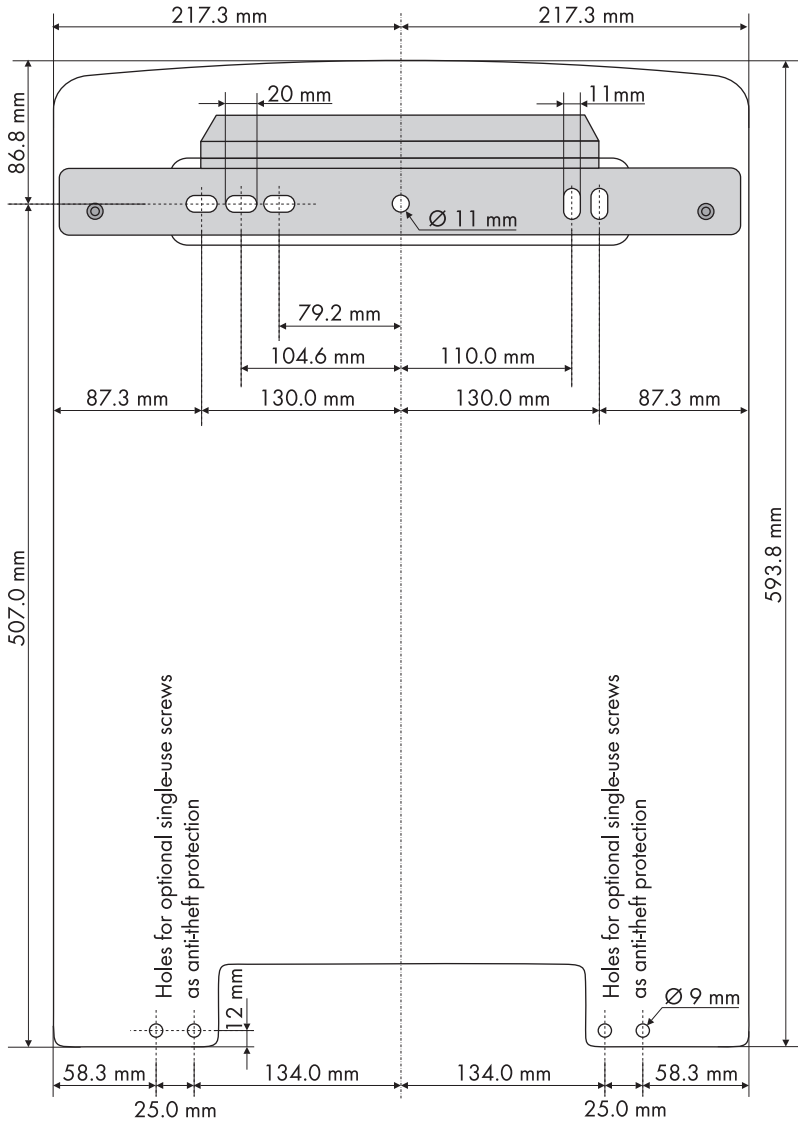



CAUTION!

Risk of injury due to the heavy weight of the inverter

The inverter weighs approx. 63 kg.

- Attach the wall mounting bracket using the corresponding mounting material (dependent on the surface).
- Use the side handles above and below or a steel rod (maximum diameter of 30 mm) for transport and mounting. The rod must be pushed through the enclosure openings.

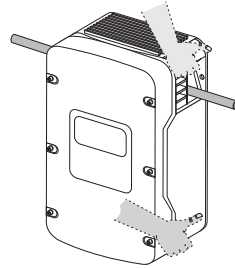

2. Secure the wall mounting bracket to the wall using appropriate screws and washers.

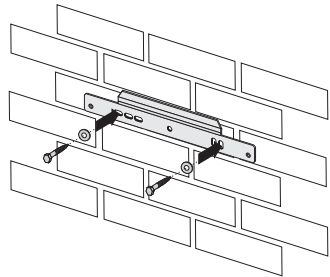

3. Hang the inverter onto the wall mounting bracket using the mounting recess in the rear of the enclosure.

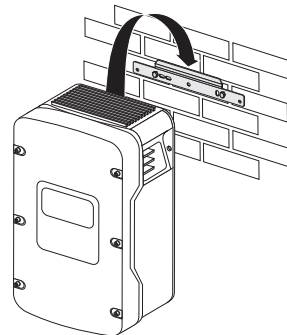

4. Screw the inverter onto the wall mounting bracket on both sides using the screws (M6x8) provided.
Only tighten the screws hand-tight.

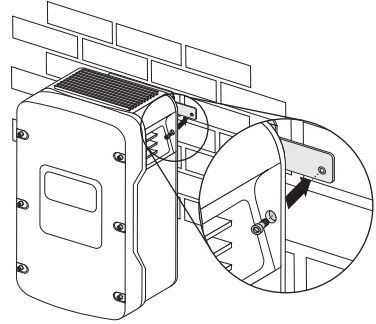

5. Check to ensure that the inverter is securely in place.
6. Close the recessed grips using the ventilation grids supplied. To help you identify the sides, the ventilation grids are marked on the inside with "rechts/right" and "links/left".

The ventilation grids prevent intrusion of dust and insects, and can be reordered from SMA Solar Technology AG as required (see Section 13 "Contact" (page 80)).

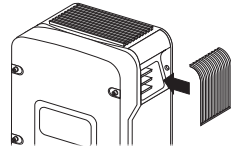

Optional Anti-Theft Protection

To protect the inverter against theft, the back panel can be secured to the wall at the bottom using two "safety screws".

The other two holes are spares.

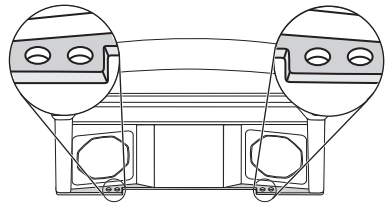

5 Electrical Connection



NOTICE!

Electrostatic discharge can damage the inverter

Internal components of the inverter can be irreparably damaged by electrostatic discharge.

- Earth yourself before touching a component part.

5.1 Overview of the Connection Area

5.1.1 Exterior View

The following figure shows the assignment of the individual connection areas on the underside of the inverter.

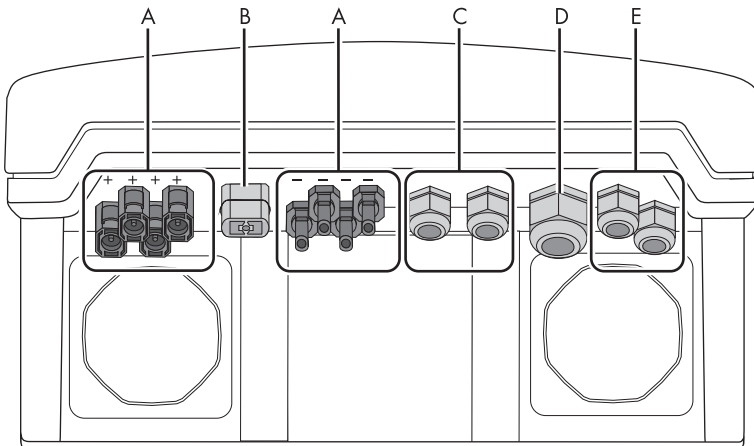

Object	Description
A	DC connectors for connecting the PV strings
B	Socket for connecting the Electronic Solar Switch (ESS) DC switch disconnector
C	Cable glands for optional communication via RS485 (PG16)
D	Cable gland for connection to the electricity grid (AC) (12 mm ... 25 mm)
E	Cable glands for the SMA Power Balancer

5.1.2 Interior View

The following figure shows the various components and connection areas of the open inverter.

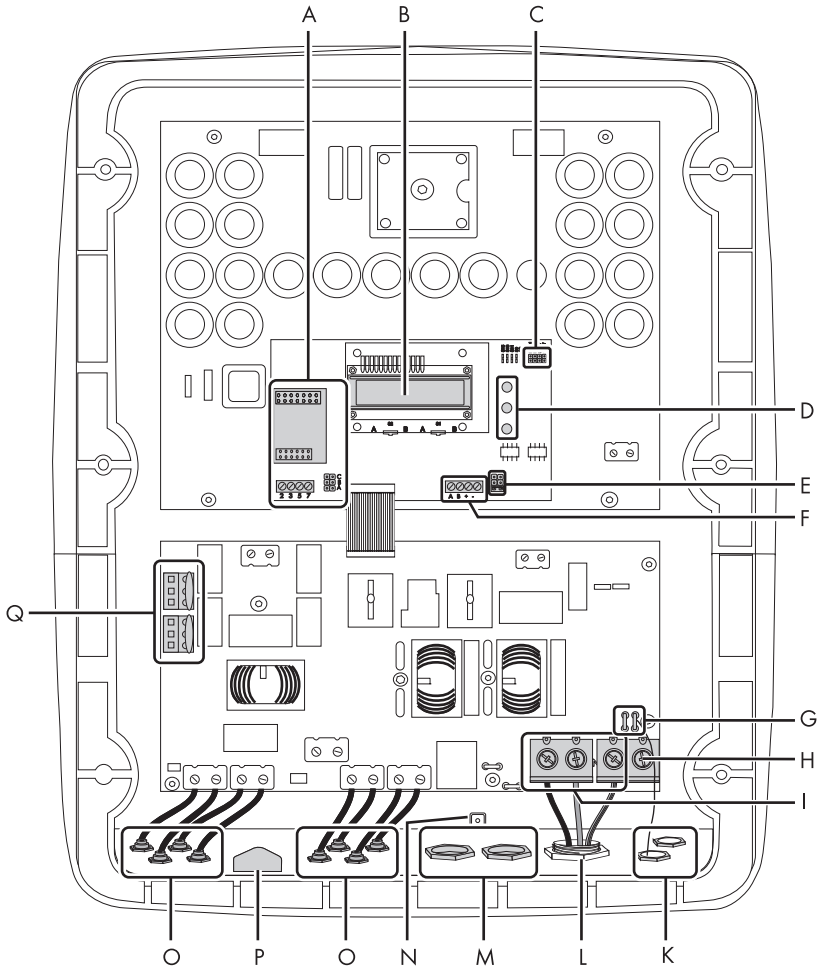

Object	Description
A	Connection area and slots for communication
B	Display
C	Jumper slot for fan test
D	LEDs for displaying the operating states
E	Jumper slot for SMA Power Balancer

Object	Description
F	Terminals for the SMA Power Balancer
G	Flat male tab for earthing the cable shield when connecting the SMA Power Balancer
H	Additional terminal for earthing
I	Terminals for AC cables
K	Cable glands for the SMA Power Balancer
L	Cable gland for the AC cable
M	Cable glands for communication
N	Screw fixture of shield connection terminal for data cable
O	DC connector
P	Connection socket for the Electronic Solar Switch (ESS)
Q	Varistors

5.2 Connection to the Electricity Grid (AC)

5.2.1 Conditions for the AC Connection



Connection requirements of the network operator

Always observe the connection requirements of your network operator.

Cable Dimensioning

Use Sunny Design Version 2.0 or higher for sizing the conductor cross-sections (see design software "Sunny Design" at www.SMA-Solar.com).



Halving the cable losses

If three inverters with symmetrical feed-in are combined to form a three-phase system, the neutral conductor is not subject to any load and the cable losses are halved. Thus, the maximum possible cable length is doubled.

Cable Requirements

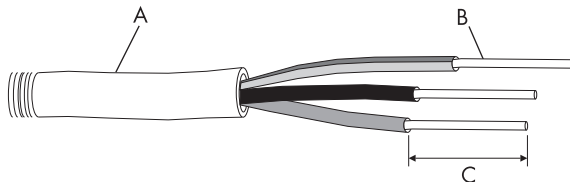

Item	Description	Value
A	External diameter	12 mm ... 25 mm
B	Conductor cross-section	6 mm ² ... 16 mm ²
C	Stripping length	approx. 16 mm

Load Disconnection Unit

You must install a **separate** miniature circuit-breaker for each inverter in order to ensure that the inverter can be securely disconnected under load. The maximum permissible fuse protection can be found in Section 11 "Technical Data" (page 70).

Detailed information and examples on the design of miniature circuit-breakers are available in the Technical Information "Miniature Circuit-Breaker" to be found in the download area of SMA Solar Technology AG at www.SMA-Solar.com.



DANGER!

Danger to life due to fire

When more than one inverter is connected in parallel to the same miniature circuit-breaker, the protective function of the miniature circuit-breaker is no longer guaranteed. This could result in a cable fire or destruction of the inverter.

- Never connect several inverters to the same miniature circuit-breaker.
- Observe the maximum permissible fuse protection of the inverter when selecting the miniature circuit-breaker.



DANGER!

Danger to life due to fire

When a generator (inverter) and a load are connected to the same miniature circuit-breaker, the protective function of the miniature circuit-breaker is no longer guaranteed. The currents from the inverter and the electricity grid can accumulate to form overcurrents which are not detected by the miniature circuit-breaker.

- Never connect loads between the inverter and the miniature circuit-breaker without fuse protection.
- Always fuse loads separately.

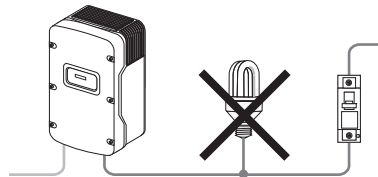

NOTICE!

Damage to the inverter by use of screw-type fuses as switch-disconnectors

A screw-type fuse, e.g. DIAZED fuse or NEOZED fuse, is not a switch-disconnector and thus may **not** be used as a load disconnection unit. A screw-type fuse only acts as cable protection.

If the inverter is disconnected under load using a screw-type fuse, the inverter may be damaged.

- Use only a switch-disconnector or a miniature circuit-breaker as a load disconnection unit.

5.2.2 Connecting the Inverter to the Electricity Grid (AC)

1. Check the mains voltage and compare with " $V_{AC, nom}$ " on the type label.
The exact operating range of the inverter is specified in the operating parameters. The corresponding document is available in the download area at www.SMA-Solar.com.
2. Disconnect the miniature circuit-breaker and secure against reconnection.
3. Loosen all screws of the enclosure lid and remove the lid.

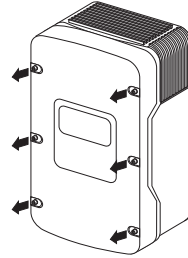

4. Remove the adhesive tape from the AC enclosure opening (see "D" on Page 20).
5. Insert the AC cable gland from the outside into the enclosure opening and tighten it from the inside using the counter nut.
6. Unscrew the cable gland's swivel nut and lead it over the cable.
7. Lead the cable through the cable gland to the AC terminal.
8. Connect L, N and the protective conductor (PE) in accordance with the labelling to the terminal blocks using a screwdriver.

The PE wire must be 5 mm longer than the L and N conductors.

L and N must not be swapped.

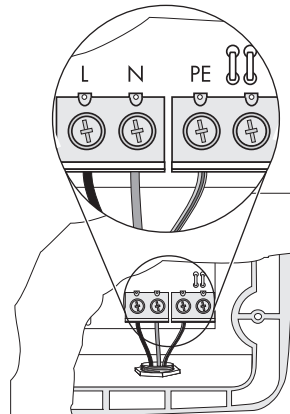

9. Screw the swivel nut firmly onto the cable gland.
10. Secure the enclosure lid using all of the screws and the corresponding conical spring washers.

Tighten the screws with 6 Nm torque in the order shown in the figure on the right. The tothing of the conical spring washers must be facing the enclosure lid.

The scope of delivery of the inverter includes a spare screw and conical spring washer.

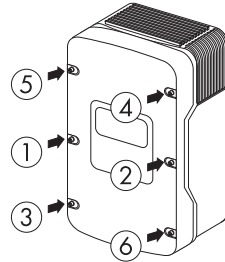

DANGER!
 Danger to life due to enclosure lid carrying voltage

The earthing of the enclosure lid is ensured by the conical spring washers.

- Attach the conical spring washers for all 6 screws with the tothing facing towards the enclosure lid.

DANGER!
 Danger to life due to high voltages in the inverter

- Do not switch on the miniature circuit-breaker until the PV array has also been connected and the inverter is securely closed.

- The inverter is connected to the electricity grid (AC).

5.2.3 Additional Earthing of the Enclosure

If the installation so requires, you can use the earth terminal to connect a second protective conductor or as equipotential bonding.

Procedure

1. Plug the stripped earthing cable (D) under the clamping bracket (C) (max. cross-section 16 mm² or with bootlace ferrule max. 10 mm²).
2. Screw the clamping bracket tight using the screw (A) and conical spring washer (B).

The tothing of the conical spring washer must face toward the clamping bracket.

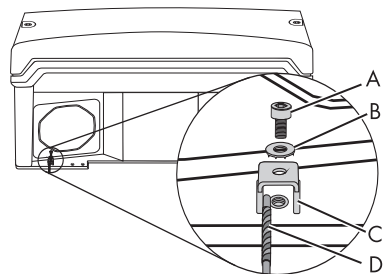

- The inverter enclosure is additionally earthed.

5.3 Setting the Display Language

You can set the language of the display using the switches at the bottom of the display assembly inside the inverter.

When selecting the display language, different switching settings apply to inverters that are set to the Italian national standard CEI 0-21. You can see the standard to which the inverter was set upon delivery on the type label and on the included supplementary sheet with the default settings. For more information, see the Technical Description "Operating Parameters" at www.SMA-Solar.com.

Procedure

1. Open the inverter as described in Section 7.2 "Opening the Inverter" (page 48).
2. Set the switches to the required language.

The following switch settings, except for CEI 0-21, apply to all national standards:

Language	Rotary switch S2	Rotary switch S1
German	B	B
English	B	A
French	A	B
Spanish	A	A

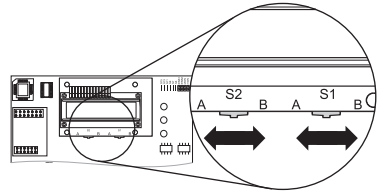

The following switch settings apply to inverters which are set to the national standard CEI 0-21:

Language	Rotary switch S2	Rotary switch S1
Italian	B	A
English	A	A
German	B	B
French	A	B

3. Close the inverter as described in Section 7.3 "Closing the Inverter" (page 51).
- The display language is set.

5.4 Connecting the PV Array (DC)

5.4.1 Conditions for DC Connection



Using Y adaptors for the parallel connection of strings

Y adaptors must not be visible or freely accessible in close proximity to the inverter.

- The DC circuit must not be interrupted by Y adaptors.
- Observe the procedure for disconnecting the inverter as described in Section 7.2 "Opening the Inverter" (page 48).
- Requirements for the PV modules of the connected strings:
 - same type
 - same quantity
 - identical alignment
 - identical tilt
- The connection cables of the PV modules must be equipped with connectors. The connectors required for DC connection are included in the scope of delivery.
- The following thresholds at the DC input of the inverter must not be exceeded:

Maximum input voltage	Maximum input current
600 V (DC)	26.0 A (DC)



WARNING!

Danger to life due to electric shock or fire

The maximum possible input current per string is limited by the connectors used. If the connectors are overloaded, an electric arc may occur and there is a risk of fire.

- Ensure that the input current per string does not exceed the maximum through-fault current of the connectors used.

5.4.2 Assembling the DC Connectors

All PV display module connection cables must be equipped with the DC connectors supplied before connecting them to the inverter.

Assemble the DC connectors as described below. Be sure to observe the correct polarity. The DC connectors are marked with the symbols "+" and "-".

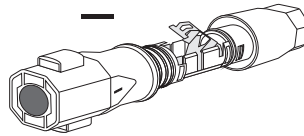
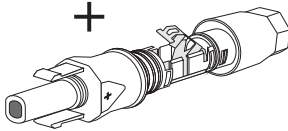

Cable requirements:

- Use a PV1-F cable.

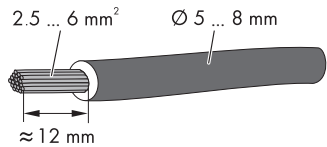

Procedure

1. Lead the stripped cable all the way into the plug.

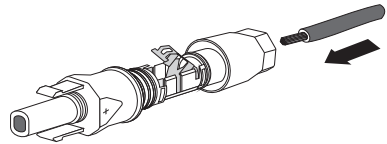

2. Press the clamping bracket down until it audibly snaps into place.

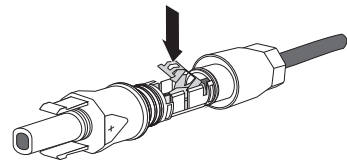

3. Ensure that the cable is correctly positioned:

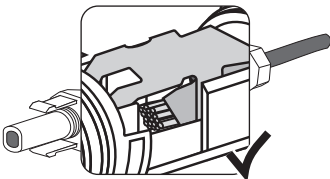
Result	Measure
<p><input checked="" type="checkbox"/> If the stranded wires are visible in the chamber of the clamping bracket, the cable is correctly positioned.</p> 	<ul style="list-style-type: none"> • Proceed to Step 4.

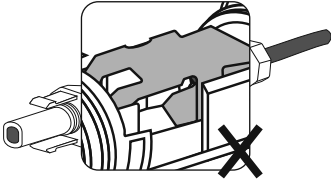
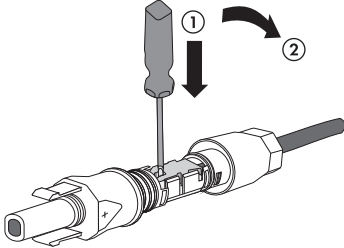
Result	Measure
<p>☑ If the stranded wires are not visible in the chamber, the cable is not correctly positioned.</p> 	<ul style="list-style-type: none"> • Release the clamping bracket. To do so, insert a screwdriver into the clamping bracket to lever it open (blade width: 3.5 mm).  <ul style="list-style-type: none"> • Remove the cable and go back to step 1.

4. Push the screw connection to the thread and fasten to a torque of 2 Nm.

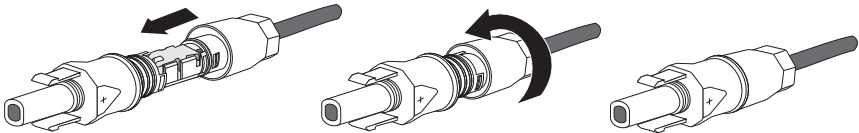

☑ The DC connectors are assembled and can now be connected to the inverter as described in Section 5.4.4 "Connecting the PV Array (DC)" (page 31).

5.4.3 Opening the DC Connector

1. Unscrew the screw connection.
2. Unlock the DC connector: Insert a screwdriver into the snap slot on the side and lever it out (blade width: 3.5 mm).

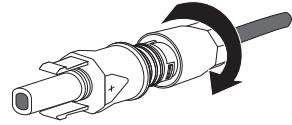

3. Carefully pull the DC connector apart.

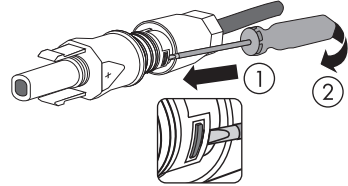

4. Release the clamping bracket. To do so, insert a screwdriver into the clamping bracket to lever it open (blade width: 3.5 mm).

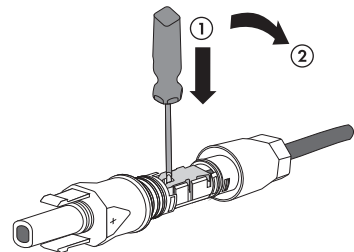
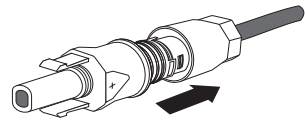

5. Remove the cable.

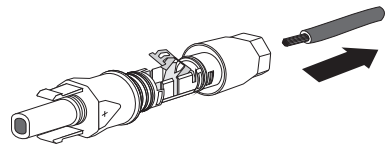

- The cable is now detached from the DC connector.

5.4.4 Connecting the PV Array (DC)



DANGER!

Danger to life due to high voltages in the inverter

- Before connecting the PV array, ensure that the miniature circuit-breaker is switched off.



NOTICE!

Excessive voltages can destroy the multimeter

- Only use multimeters with a DC input voltage range of up to at least 1,000 V.

1. Disconnect the miniature circuit-breaker and secure against reconnection.
2. Pull the Electronic Solar Switch downward, slightly towards the wall.

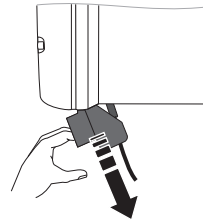

3. Check the connection cable of the PV modules for correct polarity and make sure that the maximum input voltage of the inverter is not exceeded.

At an ambient temperature above 10°C, the open-circuit voltage of the PV modules must not be more than 90% of the maximum inverter input voltage.

If this is not the case, review the plant design and the PV module circuitry. At lower ambient temperatures, the maximum input voltage of the inverter could otherwise be exceeded.

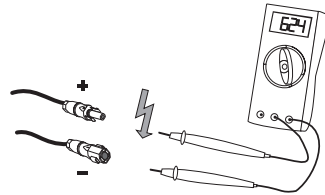

NOTICE!

Destruction of the inverter due to overvoltage

If the voltage of the PV modules exceeds the maximum input voltage of the inverter, the inverter could be destroyed by overvoltage.

This will void all warranty claims.

- Do not connect strings with an open-circuit voltage greater than the maximum input voltage of the inverter.
- Check the plant design.

4. Check the strings for earth faults as described in Section 9.3.1 "Checking the PV Array for Earth Faults" (page 64).
5. Connect the assembled DC connectors to the inverter.
 - ☑ The DC connectors click audibly into place.

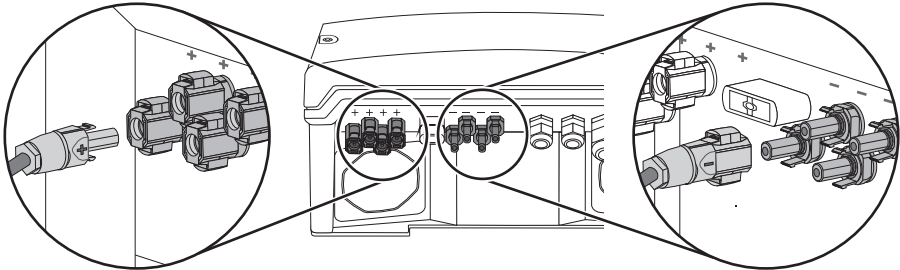

6. In order to seal the inverter, all unused DC inputs must be closed using DC connectors and sealing plugs:



Sealing plugs

- Do **not** insert the sealing plugs **directly** into the DC inputs on the inverter.
- For unused DC connectors, push down the clamping bracket and push the screw connection up to the thread.
 - Insert the sealing plug into the DC connector.
 - Tighten the DC connector (torque: 2 Nm).

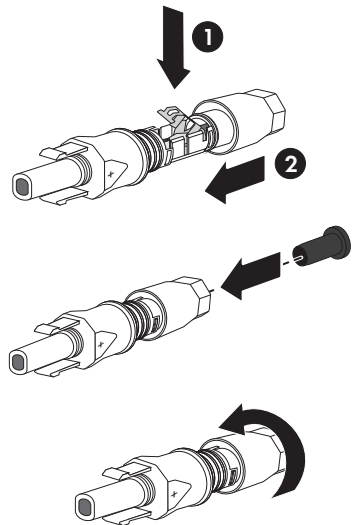

- Insert the DC connectors with sealing plugs into the corresponding DC inputs on the inverter.
- ☑ The DC connectors click audibly into place.

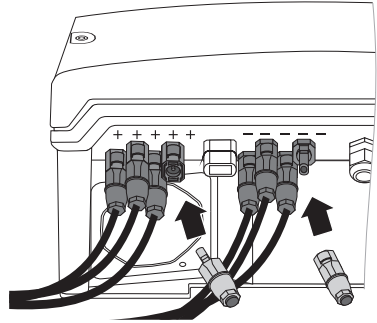

7. Ensure that all DC connectors are securely in place.
8. Check the Electronic Solar Switch for wear, as described in Section 8.3 "Checking the Electronic Solar Switch (ESS) for Wear" (page 57) and attach it firmly.

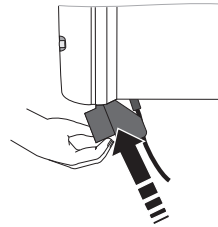
**NOTICE!****Damage to the inverter due to moisture and dust intrusion**

If the Electronic Solar Switch is not plugged in or incorrectly plugged in during operation, moisture and dust can penetrate the inverter.

If the Electronic Solar Switch is not correctly plugged in, this can cause contacts to wear in the Electronic Solar Switch or the Electronic Solar Switch might fall out. This can result in yield loss and damage to the Electronic Solar Switch.

Always plug in the Electronic Solar Switch as described in the following:

- Do not tighten the screw in the Electronic Solar Switch.
- Firmly plug in the Electronic Solar Switch until it is flush with the enclosure.
- Ensure that the maximum distance between the Electronic Solar Switch and the enclosure is 1 mm.

- ☑ The PV array is connected.

You can now commission the inverter as described in Section 6 "Commissioning" (page 44). The following connections are optional.

5.5 Connecting the SMA Power Balancer

The Sunny Mini Central is equipped with the SMA Power Balancer as standard. This enables a circuitry of three Sunny Mini Central inverters to a three-phase feed-in system.

Each of the three Sunny Mini Central inverters in a group must be connected to a different line conductor of the low-voltage grid (L1, L2 and L3).

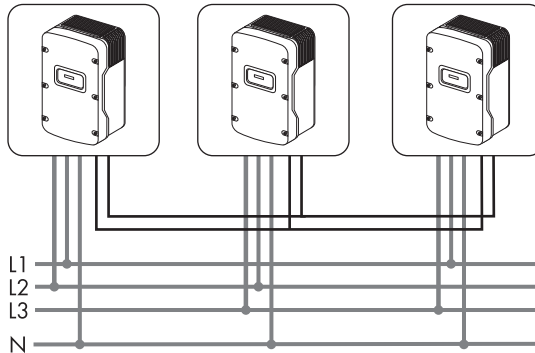

By activating this electronic circuit, you can stipulate how the other two Sunny Mini Central inverters are to react if there is a device fault with the third Sunny Mini Central or there is a mains voltage fault in its line conductor.



Three-Phase Grid Connection

For further information on this subject, see the Technical Information "Three-Phase Grid Connection with Sunny Mini Central" in the download area at www.SMA-Solar.com.

The connections for the SMA Power Balancer are galvanically isolated from the rest of the Sunny Mini Central electronic circuit.

5.5.1 Configuration

If the national standard VDE-AR-N4105-MP or VDE-AR-N4105-HP is set, the SMA Power Balancer is activated by default and set to the operating mode "PowerGuard" in SMC 4600A-11, SMC 5000A-11 and SMC 6000A-11. All other national standards deactivate the SMA Power Balancer by default in SMC 4600A-11, SMC 5000A-11 and SMC 6000A-11.

The SMA Power Balancer is always deactivated by default in SMC 4600A, SMC 5000A and SMC 6000A, regardless of the national standard set.

The SMA Power Balancer can only be activated or configured using a communication product. To change the "PowerBalancer" parameter, you need a personal access code – the so-called SMA Grid Guard code. The application form for the personal access code is available in the download area at www.SMA-Solar.com, in the "Certificate" category of the respective inverter.

The configuration options are described below.

Configuration Options

There are four different configuration options for the "PowerBalancer" parameter.



Local connection requirements

Select the respective setting and always observe the local connection requirements and provisions of your network operator.

- **FaultGuard**

This operating mode allows for the implementation of a three-phase mains voltage monitoring, which also reacts to device faults.

- If one of the three inverters indicates a **mains voltage fault** and stops feeding in, the other two inverters also disconnect from the electricity grid immediately.

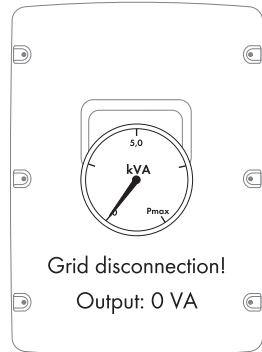
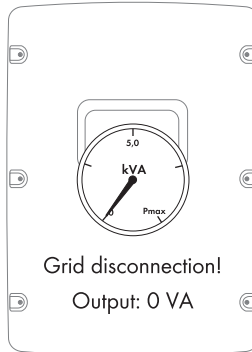
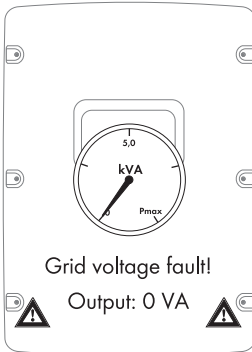

- If one of the three inverters indicates a **device fault** and stops feeding in, the other two inverters also disconnect from the electricity grid after five minutes.

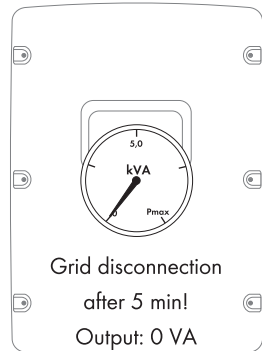
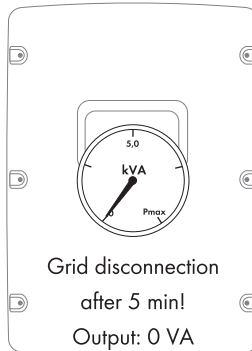
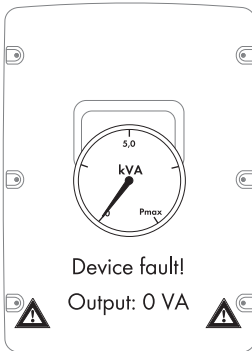

- **PhaseGuard**

This operating mode allows for the implementation of three-phase mains voltage monitoring.

- If one of the three inverters indicates a **mains voltage fault** and stops feeding in, the other two inverters also disconnect from the electricity grid automatically.

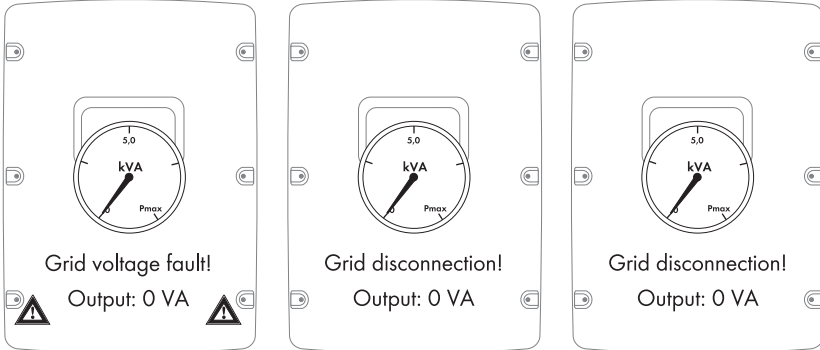

- If one of the three inverters indicates a **device fault** and stops feeding in, the other two inverters are not affected and continue to feed in at full power.

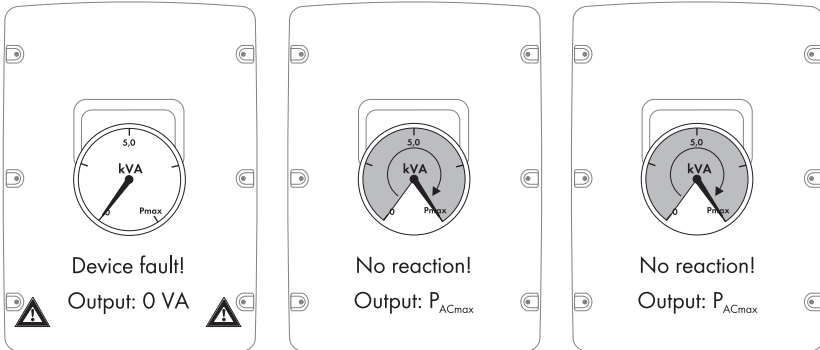

• **Off**

The SMA Power Balancer is deactivated (default setting).

- If one of the inverters displays a **device fault** or a **mains voltage fault**, only the affected inverter disconnects from the electricity grid and the other two inverters continue to feed in at full power.

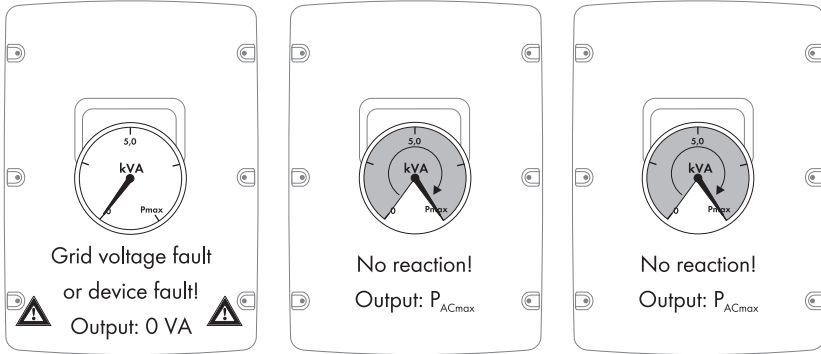

• **PowerGuard**

This setting can be selected if the entire PV plant only consists of three Sunny Mini Central inverters and in the event of a malfunction, the unbalanced load should be limited to 4.6 kVA over a 10-minute average.



Different unbalanced load limitation for SMC 6000A-11 inverters for Italy

The unbalanced load for SMC 6000A-11 inverters set to the national standard CEI 0-21 is limited to 6 kVA over a 10-minute average.

- If one of the three inverters indicates a **mains voltage fault** or **device fault** and stops feeding in, the other two inverters automatically limit their power over a 10 minute average to 4.6 kVA.

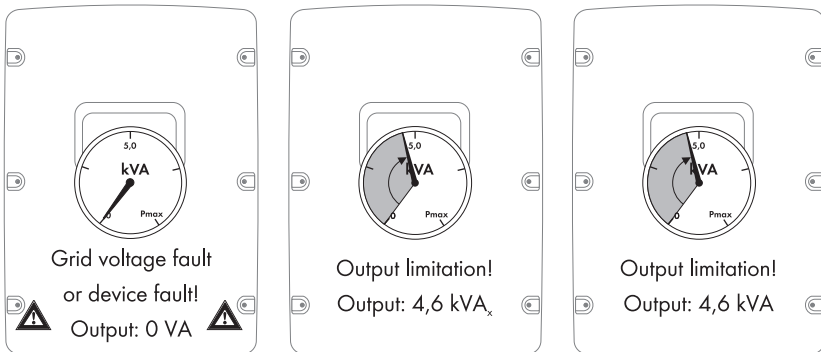

5.5.2 Cabling

Cable Requirements

To connect the SMA Power Balancer, use a "LiYCY" cable of the following design:

- Indoors: LiYCY 2 x 2 x 0.25
- Outdoors: Li-2YCYv 2 x 2 x 0.25

Item	Description
A	Flexible insulation
B	Shielding
C	Twisted pair 2 (2 x 0.25 mm ²)
D	Twisted pair 1 (2 x 0.25 mm ²)

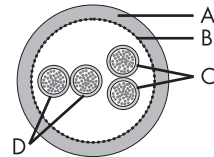

Overview of the Connection Area

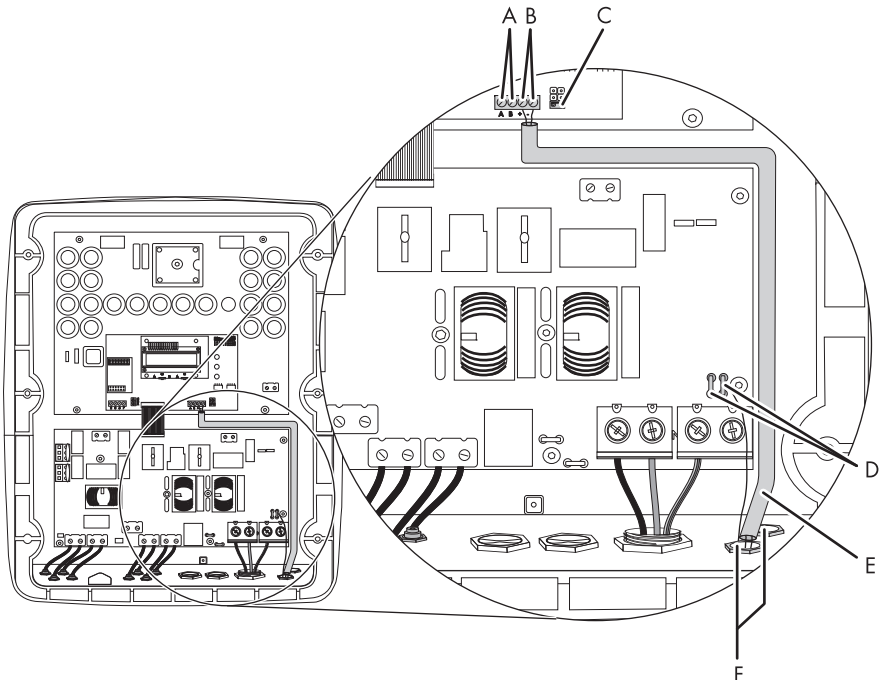

Object	Description
A	Screw terminals for the jumper wire
B	Screw terminals for connecting the cables
C	Jumper slot

Object	Description
D	Flat male tab for earthing the cable shield
E	Silicone tube/cable route
F	Cable glands

Procedure

1. Open the inverter as described in Section 7.2 "Opening the Inverter" (page 48).
2. Insert the cables into each inverter.
Use one of the two enclosure openings (F) on the right-hand side.

! DANGER!
 Danger to life due to high voltage in the event of a fault in the SMA Power Balancer cable

- Sheath the positive and negative cable conductors in each inverter using the silicone tube supplied.
- Cut the silicone tube to the required length.
- The silicone tube must completely cover the cable inside the inverter enclosure.

3. Lead the cable along the cable route (E) as far as the terminal block (B).
4. Earth the cable shield in each inverter at the PE terminal (D).
5. Sheath the positive and negative cable conductors in each inverter using bootlace ferrules.
6. Connect the positive and negative poles to the corresponding screw terminals.

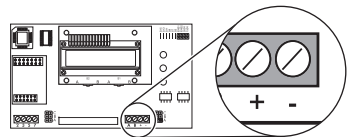

7. In order to link the three inverters, connect the positive and negative conductors from the two other inverters to the terminal block of the middle inverter.

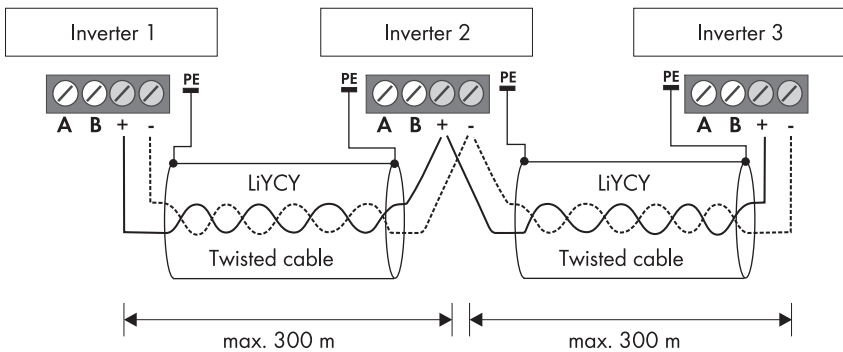

The cable length between 2 inverters may not exceed 300 m.

8. **Only** plug one of the provided jumpers into the lowest of the three slots in the **middle** inverter (the one with two insulated wires for each terminal) as depicted on the right.

Do **not** plug the jumpers in the lowest slot of the two other inverters.

or

Bridge the "A" and "B" screw terminals on the **middle** inverter using a jumper wire.

Do **not** bridge the "A" and "B" screw terminals in the two other inverters.

9. Measure the electrical resistance between the positive and negative poles of the terminal block in the **middle** inverter.

- If the resistance is approximately $27.8 \text{ k}\Omega$ ($\pm 370 \Omega$), the SMA Power Balancer has been connected correctly. If not, check the cabling.

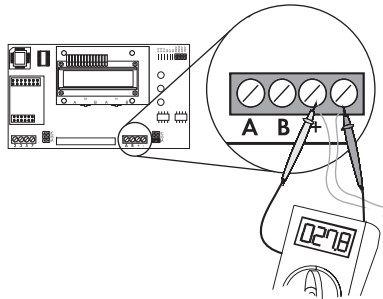
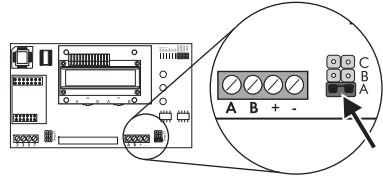

10. Close all inverters as described in Section 7.3 "Closing the Inverter" (page 51).



Connection with a Sunny Mini Central 9000TL, 10000TL or 11000TL

In order to be able to connect the SMA Power Balancer to a Sunny Mini Central 9000TL, 10000TL or 11000TL, the Sunny Mini Central 4600A, 5000A, 6000A must be equipped with a special plug. Three inverters are then connected together using a special connection cable.

You can order the plug and the connection cable from SMA Solar Technology AG or your specialist dealer. Section 12 "Accessories" (page 79) contains a list of the order numbers.

5.5.3 Function Test

To test whether the SMA Power Balancer operates correctly, proceed as follows.

1. Select the "PhaseGuard" setting of the "PowerBalancer" parameter for all three inverters.
2. Check whether all inverters in the group are feeding into the electricity grid normally.

- If the green LED is glowing continuously or if the display message shown on the right appears, proceed to step 3.



or

- If all inverters in this group show the display message shown on the right: check the installation of the SMA Power Balancer and contact the SMA Service Line if necessary.

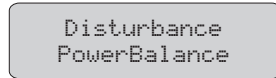

3. Switch off the miniature circuit-breaker of one of the three inverters.

- The inverter with the deactivated miniature circuit-breaker will then indicate a mains voltage fault via the display message shown on the right ("Bfr" and "Srr" are not relevant).

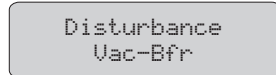

- The other two inverters will then also disconnect from the electricity grid, displaying the display message shown on the right.

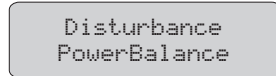

- Both inverters subsequently switch to "Balanced" mode.



- If the inverters react as described above, the function test has been completed successfully. If not, check the configuration.

4. If applicable, reset the "PowerBalancer" parameter to the desired setting in all inverters.
5. Switch the miniature circuit-breaker on again.

- The function test is complete.

5.6 Communication

The inverter is equipped with a slot for communication interfaces in order to communicate with special data loggers (e.g., Sunny WebBox) or a PC with corresponding software (e.g., Sunny Data Control or Sunny Explorer).

Refer to the respective communication interface manual for a detailed wiring diagram and an installation description for the interface.

The active power of the inverter can be limited or its displacement power factor can be set externally using the Power Reducer Box from SMA Solar Technology AG. Detailed information on the Power Reducer Box is available in its technical description at www.SMA-Solar.com.

5.7 Setting the Grid and Country Parameters



Changing grid-relevant parameters and country parameters

To change grid-relevant parameters, you need a personal access code – the so-called SMA Grid Guard code. The application form for the personal access code is available in the download area at www.SMA-Solar.com, in the "Certificate" category of the respective inverter.

You **must** discuss changes to these parameters with your network operator.

A detailed description of the operating parameters for the inverter is available in the download area at www.SMA-Solar.com in the category "Technical Description" of the respective inverter.

5.7.1 Setting the Installation Country

Using the "Default" parameter, you can set the country of installation and/or the grid connection standard valid for that country via a communication product (e.g., Sunny WebBox) or a PC with corresponding software (e.g., Sunny Data Control or Sunny Explorer). This, however, is only required if the inverter was originally ordered for another country. You can see the standard to which the inverter was set upon delivery on the type label and on the included supplementary sheet with the default settings.

5.7.2 Setting the Stand-Alone Grid Operation

To operate the inverter in an off-grid system with Sunny Island, you must set the "Default" parameter to stand-alone grid ("OFF-Grid") operation.

There are several ways of setting the inverter to stand-alone grid operation:

- Setting via Sunny WebBox
- or**
- Setting via Sunny Data Control or Sunny Explorer



DANGER!

Danger to life due to high voltages in the event of electricity grid failure

If you set the inverter to stand-alone grid operation, it does not fulfil any country-specific standards or guidelines. If there is an electricity grid outage, there will consequently be a danger of backfeed.

- **Never** operate the inverter directly on the electricity grid when set to stand-alone grid operation.

5.7.3 Additional Country Parameters



Requirement for the setting

Set the installation country as described in Section 5.7.1 "Setting the Installation Country" (page 42) before setting the country parameter described here.

The deactivation criteria (voltage, frequency, impedance) are specified via country parameters as with all Sunny Mini Central inverters.

The additional default country parameter "MvtgDirective" expands the deactivation limits of the inverter for voltage and frequency to a maximum/minimum. This country setting may only be selected if the PV plant or the inverter is operated with external three-phase decoupling protection, which will automatically disconnect the inverter from the electricity grid if non-permissible voltage and frequency values occur. Device protection is still guaranteed.



DANGER!

Danger to life due to electric shock if external decoupling protection is missing

With the country setting "MvtgDirective", the inverter may only be operated with an external three-phase decoupling protection device which complies with the country-specific requirements.

Without such external decoupling protection, the inverter will not disconnect from the electricity grid when the standard requirement is exceeded.

- Install external three-phase decoupling protection.

6 Commissioning

6.1 Commissioning the Inverter

1. Check the following requirements before commissioning:
 - The inverter is securely in place
 - AC cables are correctly connected (electricity grid)
 - DC cables (PV strings) are fully connected
 - Unused DC inputs are closed using the corresponding DC connectors and sealing plugs
 - The enclosure lid is securely screwed into place
 - The Electronic Solar Switch is securely connected
 - The miniature circuit-breaker is correctly sized

2. Switch the miniature circuit-breaker on.

- All three LEDs glowing or flashing: the startup phase commences.
- Green LED is glowing: commissioning successful.

or

- Green LED will flash if irradiation is insufficient: grid connection conditions have not yet been reached. Wait for sufficient irradiation.

or

- The red or yellow LED is glowing or flashing: there is a disturbance. Proceed to step 3.

A	Green LED	Operation
B	Red LED	Earth fault or varistor defective
C	Yellow LED	Disturbance

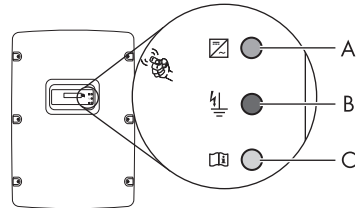

Self-test in accordance with CEI 0-21 during initial start-up of SMC 6000A (applies to Italy only)

The Italian standard CEI 0-21 prescribes that an inverter can only operate on the electricity grid after the disconnection times for overvoltage, undervoltage, minimum frequency and maximum frequency have been checked.

Start the self-test as described in Section 6.2 "Only for Italy: Self-Test in Accordance with CEI 0-21" (page 45). The test takes approx. 8 minutes.

3. Read Section 9 "Troubleshooting" (page 58) and if necessary, eliminate the fault or disturbance.

6.2 Only for Italy: Self-Test in Accordance with CEI 0-21

6.2.1 Starting the Self-Test

The self-test only applies to inverters of type SMC 6000A-11 which are commissioned in Italy.

The Italian standard requires that all inverters in plants ≤ 6 kW feeding into the electricity grid perform a self-test in accordance with CEI 0-21. During the self-test, the inverter will check the reaction times for overvoltage consecutively, undervoltage, maximum frequency and minimum frequency.

The self-test changes the upper and lower trip-limit values for each protective function on a linear basis for frequency monitoring and voltage monitoring. As soon as the measured value exceeds the permitted trip-limit value, the inverter disconnects from the electricity grid. In this way, the inverter determines the reaction time and checks itself.

After the self-test has been completed, the inverter automatically switches back to the feed-in operation, resets the original shutdown conditions and connects to the electricity grid.

Requirements:

- Country data set must be configured to **CEIO-21 Int / CEI 0-21 intern.**
- or**
- Country data set must be configured to **trimmed / Special setting** based on **CEIO-21 Int / CEI 0-21 intern.**
- A report for entering the test results in compliance with CEI 0-21 must be available.
- The inverter must be in operation and in the start-up phase.

1. As soon as the configured country data set appears in the display, tap once on the display within ten seconds.

A message informing you that the self-test has started is shown in the display:

Avvio Autotest.

If the information **Avvio Autotest** is not shown in the display, the period of ten seconds has expired and the self-test does not start.

- Restart the self-test (see Section 6.2.3).

2. Tap on the display within 20 seconds and enter the test results into the test report as they appear.

The self-test starts.

The inverter displays the results of the individual tests for overvoltage, undervoltage, maximum frequency and minimum frequency. The results are displayed three times in succession for ten seconds each.

Example: Display messages for overvoltage test

- Name of the test: **Autotest (59.S1) 240.00V**
- Disconnection value: **Valore di soglia con 230,00 V**
- Normative value: **Va. taratura 253.00V**
- Disconnection time: **Tempo intervento 0.02s**
- Current mains voltage: **Tensione di rete Val. eff.: 229.80V**

6.2.2 Abortion of the Self-Test

If, during the self-test, an unexpected disconnection requirement occurs, the self-test is aborted. The same applies if the DC voltage is so low that feed-in cannot be continued.

- A message informing you that the self-test has been aborted is shown in the display for ten seconds: **Autotest interrotto**.
- Restart the self-test (see Section 6.2.3).

6.2.3 Restarting the Self-Test

1. Disconnect the miniature circuit-breaker and secure against reconnection.
2. Remove the ESS from the inverter for five minutes and then plug it in again firmly.



NOTICE!

Damage to the inverter due to moisture and dust intrusion

If the Electronic Solar Switch is not plugged in or incorrectly plugged in during operation, moisture and dust can penetrate the inverter.

If the Electronic Solar Switch is not correctly plugged in, this can cause contacts to wear in the Electronic Solar Switch or the Electronic Solar Switch might fall down. This can result in yield loss and damage to the Electronic Solar Switch.

Always plug in the Electronic Solar Switch as described in the following:

- Do not tighten the screw in the Electronic Solar Switch.
- Firmly plug in the Electronic Solar Switch until it is flush with the enclosure.
- Ensure that the maximum distance between the Electronic Solar Switch and the enclosure is 1 mm.

3. Restart the inverter
 - The inverter is once again in the start-up phase and you can start the self-test (see Section 6.2.1).

6.3 Display Messages During the Start-up Phase

- After commissioning, the inverter displays the device type in the start-up phase.

SMC xxx
Wrxxx

- After five seconds or a further tap on the enclosure lid, the firmware version of the internal processors is displayed by the inverter.
- After another five seconds or a further tap, the inverter displays the configured country standard (example: "VDE-AR-N4105-MP").

Sunny Mini Central
Wrxx

BFR Version x.xx
SRR Version x.xx

VDE-AR-N4105-MP





Showing display messages again

If you want to view the display messages of the start-up phase again during normal operation, tap the enclosure lid twice in quick succession.

7 Opening and Closing

7.1 Safety

	<p>DANGER! Danger to life due to electric shock</p>
<p>Before opening the inverter, observe the following:</p> <ul style="list-style-type: none"> • Ensure that no voltage is present on the AC side. • Ensure that neither voltage nor current is present on the DC side. 	

	<p>NOTICE! Electrostatic discharge can damage the inverter</p>
<p>The internal components of the inverter can be irreparably damaged by electrostatic discharge.</p> <ul style="list-style-type: none"> • Earth yourself before touching a component part. 	

7.2 Opening the Inverter

1. Disconnect the miniature circuit-breaker and secure against reconnection.
2. Pull the Electronic Solar Switch downward, slightly towards the wall.

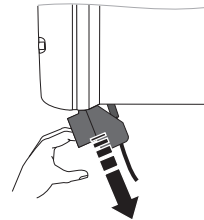

3. Use a current clamp to ensure that no current is present in all of the DC cables.
 - If current is present, check the installation.

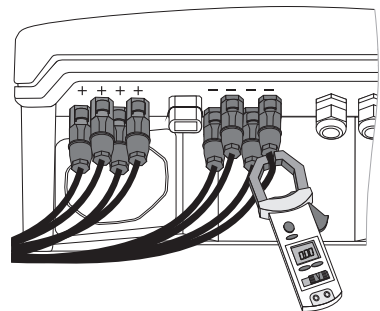

4. Release and disconnect all DC connectors. To do this, insert a flat-blade screwdriver (blade width: 3.5 mm) into one of the side slots and pull the DC plug connectors straight out. Do **NOT PULL ON THE CABLE**.

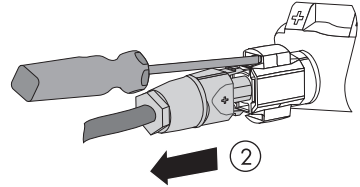
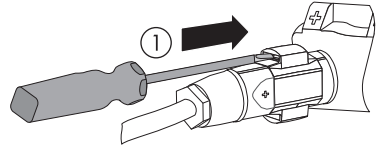

- ☑ All DC connectors are now disconnected from the inverter. The inverter is completely disconnected from the PV array.

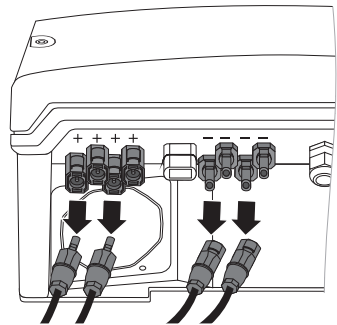



DANGER!
Danger to life due to high voltages in the inverter

The capacitors in the inverter take 5 minutes to discharge.

- Wait 5 minutes before opening the inverter.

5. Ensure that no voltage is present at the DC plugs on the inverter.
 - ☑ If voltage is present, check the installation.

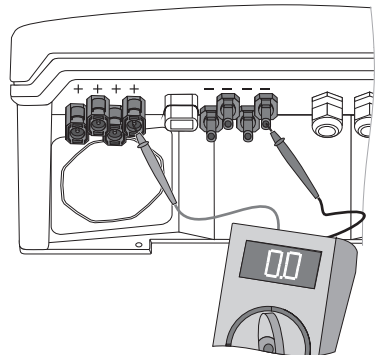

6. Loosen all 6 screws of the enclosure lid and remove the enclosure lid from the front.

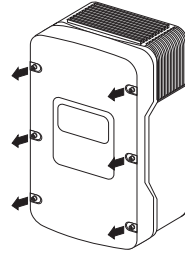

7. Verify the absence of voltage between L to N at the AC terminal using a suitable measuring device.

If voltage is present, check the installation.

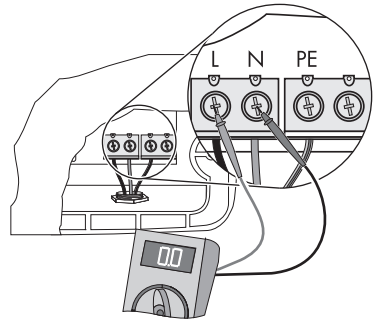

8. Verify that no voltage is present between L and PE at the AC terminal using a suitable measuring device.

If voltage is present, check the installation.

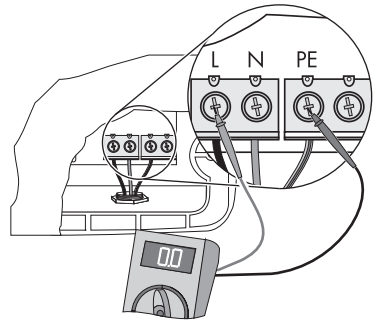

- The inverter is open and no voltage is present.

7.3 Closing the Inverter

1. Screw the enclosure lid on using the six screws and the corresponding conical spring washers.

Tighten the screws with 6 Nm torque in the order shown in the figure on the right. The tothing of the conical spring washers must be facing the enclosure lid.

The scope of delivery of the inverter includes a spare screw and conical spring washer.

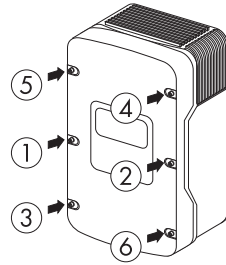

DANGER!

Danger to life due to enclosure lid carrying voltage

The earthing of the enclosure lid is ensured by the conical spring washers.

- Attach the conical spring washers for all six screws with the tothing facing towards the enclosure lid.

2. Check the DC connectors for correct polarity and plug them in.
To release the DC connectors see Section 7.2 "Opening the Inverter" (page 48).

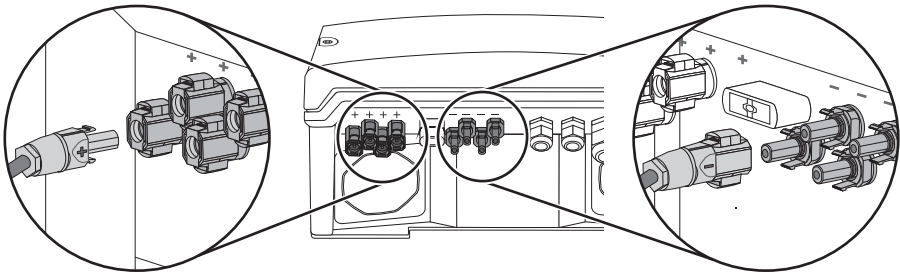

3. Close all the DC inputs that are not needed as described in Section 5.4.4 "Connecting the PV Array (DC)" (page 31) to seal the inverter.

4. Check the Electronic Solar Switch for wear as described in Section 8.3 and attach it firmly.

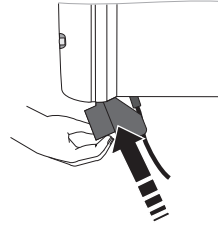

NOTICE!

Damage to the inverter due to moisture and dust intrusion

If the Electronic Solar Switch is not plugged in or incorrectly plugged in during operation, moisture and dust can penetrate the inverter.

If the Electronic Solar Switch is not correctly plugged in, this can cause contacts to wear in the Electronic Solar Switch or the Electronic Solar Switch might fall down. This can result in yield loss and damage to the Electronic Solar Switch.

Always plug in the Electronic Solar Switch as described in the following:

- Do not tighten the screw in the Electronic Solar Switch.
- Firmly plug in the Electronic Solar Switch until it is flush with the enclosure.
- Ensure that the maximum distance between the Electronic Solar Switch and the enclosure is 1 mm.

5. Switch the miniature circuit-breaker on.
6. Check whether the display and the LEDs indicate a normal operating state (see Section 6 "Commissioning" (page 44)).

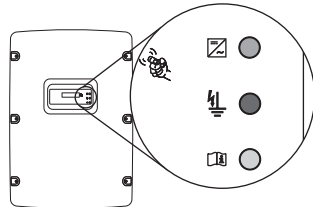

- The inverter is now closed and in operation.

8 Maintenance and Cleaning

8.1 Cleaning the Inverter

If the inverter is dirty and it is difficult to read the operating data and operating states of the inverter, clean the enclosure lid, the display and the LEDs using a damp cloth. Do not use any corrosive substances (e.g. solvents or abrasives) for cleaning.

8.2 Checking Heat Dissipation

8.2.1 Cleaning the Fans

If the fan guards are soiled with loose dust, they can be cleaned using a vacuum cleaner. If you do not achieve satisfactory results with a vacuum cleaner, dismantle the fans for cleaning.

Procedure

1. Disconnect the inverter from both the DC and AC sides as described in Section 7.2 "Opening the Inverter" (page 48).
2. Wait for the fans to stop rotating.

Cleaning the fan guards

3. Remove the fan guards:
 - Use a screwdriver to press both latches at the right edge of the fan guard to the right and dislodge it from the retainer.
 - Carefully remove the fan guard.

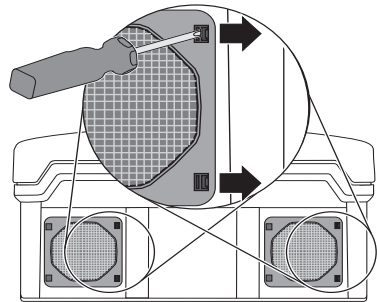

4. Clean the fan guard using a soft brush, a paint brush, a cloth or compressed air.

Cleaning the Fans

5. Press the front latches backward and the rear latch forward.

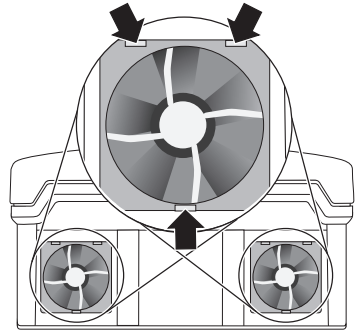

6. Remove the fan by pulling it slowly and carefully downwards.
7. Unlock and remove the plug.
The fan cables are long enough for you to lift the fans far enough out to disconnect the plug inside the inverter.
8. Remove the fan.
9. Clean the fan using a soft brush, a paint brush, or a damp cloth.



NOTICE!

Damage to the fan through use of compressed air

- Do not use compressed air to clean the fan. This could damage the fan.

10. After cleaning, reassemble everything in reverse order.
- The fans are cleaned.
11. Check the function of the fan as described in the following section.

8.2.2 Checking the Fans

There are two ways to check that the fans are working:

- Set the "Fan Test" parameter to "1" in the installer mode using Sunny Data Control, Sunny Explorer or Sunny WebBox.
- or**
- Plug the provided jumper into the system control board.

Setting Parameters

1. Request the installer password from the SMA Service Line (contact: see Page 80).
2. Set the "Fan-Test" parameter to "1" in the installer mode.
3. Check the air flow of the fans.

The inverter draws air in from underneath and then blows it back out on either side at the top. Listen for any unusual noise, which could indicate incorrect installation or a fault in the fans.

4. After checking the fans, set the "Fan-Test" parameter back to "0".
- The fan test is now complete.

Plugging the Jumper

The inverter recognizes the jumper only after a system restart (i.e. all LEDs must have gone out prior to restart).

1. Open the inverter as described in Section 7.2 "Opening the Inverter" (page 48).
2. Plug the provided jumper in the slot on the system control board as shown below.

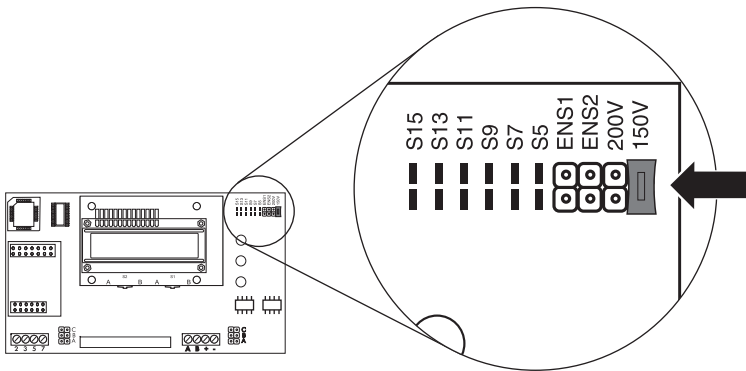

3. Close the inverter as described in Section 7.3 "Closing the Inverter" (page 51).
4. Check the air flow of the fans.

The inverter draws air in from underneath and then blows it back out on either side at the top. Listen for any unusual noise, which could indicate incorrect installation or a fault in the fans.

5. After checking the fans, remove the jumper. Open and close the inverter as described in Section 7 "Opening and Closing" (page 48).
- The fan test is now complete.

8.2.3 Cleaning the Ventilation Grids

The inverter takes cooling air in from underneath via the fans and blows it out again through the ventilation grid on the upper sides. Clean the ventilation grids if they are dirty.

Procedure

1. Remove the ventilation grids.

To do this, insert your finger into the top of the space between ventilation grid and enclosure and remove the ventilation grid laterally.

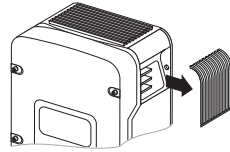

2. Clean the ventilation grids using a soft brush, a paint brush, or compressed air.
3. Re-attach the ventilation grids to the inverter.

The ventilation grids must be attached in accordance with the inside inscription ("links/left" and "rechts/right").

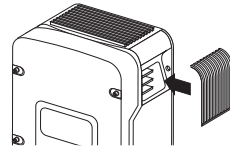

NOTICE!

Risk of damage to the inverter through intrusion of insects

- The ventilation grids must not be removed permanently, as otherwise the device will not be protected against the intrusion of insects.

8.3 Checking the Electronic Solar Switch (ESS) for Wear

Check the Electronic Solar Switch for wear before plugging it in. Depending on the shape of the Electronic Solar Switch, you can estimate the wear on either the metal tongues (shape A) or on the plastic (shape B).

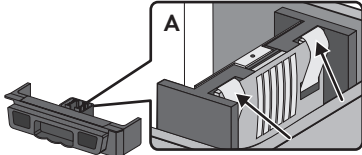
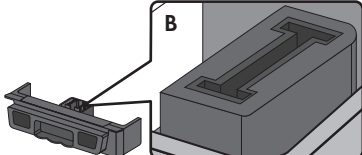
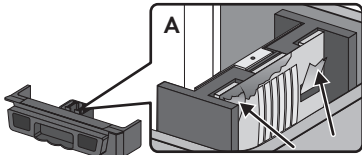
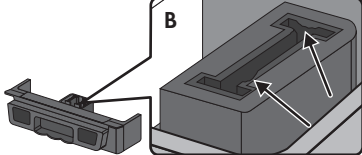
Result	Measure
<p><input checked="" type="checkbox"/> The metal tongues in the Electronic Solar Switch are undamaged and not discoloured (A).</p>  <p>or</p> <p><input checked="" type="checkbox"/> The plastic in the Electronic Solar Switch is undamaged (B).</p> 	<ol style="list-style-type: none"> 1. Securely attach the Electronic Solar Switch handle. 2. Commission the inverter as described in Section 6 "Commissioning" (page 44).
<p><input checked="" type="checkbox"/> The metal tongues in the Electronic Solar Switch have a brown discolouration or are burned through (A).</p>  <p>or</p> <p><input checked="" type="checkbox"/> The plastic in the Electronic Solar Switch shows thermal deformation (B).</p> 	<p>The Electronic Solar Switch can no longer reliably disconnect the DC side.</p> <ol style="list-style-type: none"> 1. Replace the Electronic Solar Switch handle before re-attaching (for the order number see Section 12 "Accessories" (page 79)). 2. Recommission the inverter as described in Section 6 "Commissioning" (page 44).

9 Troubleshooting

If the inverter displays blink codes or error messages which differ from those described below, contact the SMA Service Line.

You will find a description of display messages during operation, status messages and measurement channels in the user manual provided.

Do not perform any repairs that are not described here and take advantage of the 24-hour replacement service (inverter ready for shipping and handed over to a freight-forwarding company within 24 hours) and the SMA Solar Technology AG repair service instead.

9.1 Blink Codes

Green	Red	Yellow	Status
Flashing	flashing	flashing	OK (start-up phase)
Permanently glowing	is not glowing	is not glowing	OK (feed-in operation)
	permanently glowing	is not glowing	Earth fault or varistor defective
		permanently glowing	OK (initialisation)
Is flashing quickly (3 x per second)	is not glowing	is not glowing	OK (stop)
	permanently glowing	is not glowing	Earth fault or varistor defective
Is flashing slowly (1 x per second)	is not glowing	is not glowing	OK (waiting, grid monitoring)
Goes out briefly (approx. 1 x per second)	permanently glowing	is not glowing	Earth fault or varistor defective
	is not glowing	is not glowing	OK (derating)
Is not glowing	is not glowing	is not glowing	OK (night-time deactivation or Electronic Solar Switch not connected)
		is glowing / flashing	Disturbance
	permanently glowing	is not glowing	Earth fault or varistor defective
		is glowing / flashing	Earth fault or varistor defective and disturbance

9.2 Error Messages

If a disturbance occurs, the inverter generates a message which depends on the operating mode and the type of the disturbance detected.

Message	Description and corrective measure
!PV-Overvoltage! !DISCONNECT DC!	Overvoltage at the DC input. Overvoltage can destroy the inverter.
	<p>Corrective measures</p> <p>Immediately disconnect the inverter from the electricity grid.</p> <ol style="list-style-type: none"> 1. Disconnect the miniature circuit-breaker. 2. Remove the Electronic Solar Switch. 3. Remove all DC connectors. 4. Check the DC voltage: <ul style="list-style-type: none"> - If the DC voltage is above the maximum input voltage, check the PV plant design or contact the PV array installer. - If the DC voltage is below the maximum input voltage, reconnect the inverter to the PV array as described in Section 5.4.4 "Connecting the PV Array (DC)" (page 31). <p>If the message occurs again, disconnect the inverter again and contact the SMA Service Line (see Section 13 "Contact" (page 80)).</p>
ACVtgRPro	<p>The 10-minute average mains voltage is no longer within the permissible range. This can be caused by one of the following:</p> <ul style="list-style-type: none"> • The mains voltage at the termination point is too high. • The grid impedance at the termination point is too high. <p>The inverter disconnects from the grid to maintain power quality.</p>
	<p>Corrective measures</p> <p>Check the mains voltage at the termination point of the inverter:</p> <ul style="list-style-type: none"> • If, due to the local grid conditions, the mains voltage is 253 V or more, ask the network operator whether the voltage at the feed-in point can be adjusted, or whether they would agree to an alteration of the limiting value of parameter "ACVtgRPro" for power quality monitoring. • If the mains voltage is continually within the tolerance range and this error message is still displayed, contact the SMA Service Line.
Bfr-Srr	Internal measurement comparison fault or hardware defect.
	<p>Corrective measures</p> <ul style="list-style-type: none"> • Contact the SMA Service Line if this disturbance occurs frequently.

Message	Description and corrective measure
Derating	The "Derating" operating state is a normal operating state which may occur occasionally and can have several causes. Once the inverter enters the "Derating" operating state, it will display the "Derating" warning until the next complete disconnection of the device (at the end of the day).
	Corrective measures <ul style="list-style-type: none"> • Check the heat dissipation as described in Section 8.2 "Checking Heat Dissipation" (page 53).
EEPROM	Transition disturbance while data is being written or read from EEPROM. The data is not relevant for safe operation. <ul style="list-style-type: none"> • This disturbance has no effect on the performance of the inverter.
EEPROM dBh	EEPROM data is defective, the inverter has switched off because the loss of data has disabled important functions of the inverter.
	Corrective measures <ul style="list-style-type: none"> • Contact SMA Service Line.
EeRestore	One of the duplicate records in the EEPROM is defective and has been reconstructed without loss of data. <ul style="list-style-type: none"> • This error message only serves to inform you and has no effect on the performance of the inverter.
Fac-Bfr Fac-Srr FacFast	The mains frequency is no longer within the permissible range ("Bfr"/"Srr"/"Fast" is an internal message that has no meaning for the user). The inverter disconnects from the electricity grid for safety reasons.
	Corrective measures <ul style="list-style-type: none"> • Check the grid connection and contact the network operator if necessary. • If the mains frequency is within the tolerable range, but "Fac-Bfr", "Fac-Srr" or "FacFast" faults are still displayed, contact the SMA Service Line.
K1-Close K1-Open	Error during relay test.
	Corrective measures <ul style="list-style-type: none"> • Contact the SMA Service Line if this disturbance occurs frequently or several times in a row.
Imax	Overcurrent on the AC side. This message is displayed if the current in the AC electricity grid is higher than specified.
	Corrective measures <ul style="list-style-type: none"> • Check the plant design and grid conditions.

Message	Description and corrective measure
MSD-Fac	Internal measurement comparison fault or hardware defect.
	Corrective measures <ul style="list-style-type: none"> • Contact the SMA Service Line if this disturbance occurs frequently.
MSD-Vac	Internal measurement comparison fault or hardware defect.
	Corrective measures <ul style="list-style-type: none"> • Contact the SMA Service Line if this disturbance occurs frequently.
MSD-Timeout	Internal measurement comparison fault or hardware defect.
	Corrective measures <ul style="list-style-type: none"> • Contact the SMA Service Line if this disturbance occurs frequently.
Offset	The "offset" operating state is a normal operating state that occurs prior to grid monitoring. If "offset" is displayed as an error, there is a disturbance in the recording of measured values.
	Corrective measures <ul style="list-style-type: none"> • Contact the SMA Service Line if this disturbance occurs frequently.
PowerBalance	The Sunny Mini Central is part of a three-phase system with two further Sunny Mini Central inverters equipped with the SMA Power Balancer for preventing unbalanced loads. The operating parameter "PowerBalancer" has been set to "PhaseGuard" or "FaultGuard".
	Corrective measures <ul style="list-style-type: none"> • For detailed descriptions of the operation modes "PhaseGuard" and "FaultGuard", refer to Section 5.5 "Connecting the SMA Power Balancer" (page 34).
Riso	The electrical insulation between the PV plant and earth is defective. The electrical resistance between the DC positive and/or DC negative terminal and earth is outside the defined limit range.
	Corrective measures <ul style="list-style-type: none"> • Check the insulation of the PV plant. • Check the PV plant for earth faults as described in Section 9.3.1 "Checking the PV Array for Earth Faults" (page 64).
ROM	The inverter firmware is faulty.
	Corrective measures <ul style="list-style-type: none"> • Contact the SMA Service Line if this disturbance occurs frequently.
Trafo-Temp-F	Temperatures in the transformer have exceeded the acceptable limit. The inverter stops feeding in until the temperature reverts to within the acceptable range.
	Corrective measures <ul style="list-style-type: none"> • If this disturbance occurs frequently, check the heat dissipation.

Message	Description and corrective measure
Trafo-Temp-W	If the transformer temperature has risen above the acceptable level, the inverter stops feeding in until the temperature has reverted to an acceptable level and the feed-in operation can be resumed. The "Trafo-Temp-W" warning is displayed until the device is completely disconnected.
	Corrective measures <ul style="list-style-type: none"> • Check the heat dissipation of the inverter.
Shutdown	Temporary inverter disturbance.
	Corrective measures <ul style="list-style-type: none"> • Contact SMA Service Line.
Vac-Bfr Vac-Srr	The mains voltage is no longer within the permissible range ("Bfr" or "Srr" is an internal message of no relevance for the user). This disturbance can be caused by any of the following conditions: <ul style="list-style-type: none"> • electricity grid disconnected (miniature circuit-breaker, fuse), • AC cable is interrupted or • AC cable is highly resistive. The inverter disconnects from the electricity grid for safety reasons.
	Corrective measures <ul style="list-style-type: none"> • Check the mains voltage and grid connection on the inverter. • If the mains voltage lies outside the acceptable range because of local grid conditions, ask the network operator if the voltages can be adjusted at the feed-in point or if they agree to changes in the values of the monitored operating limits (operating parameters: Vac-Min and Vac-Max). • If the mains voltage lies within the tolerance range, yet "Vac-Bfr" or "Vac-Srr" faults are still displayed, contact the SMA Service Line.

Message	Description and corrective measure
VpvMax	Overvoltage at the DC input. The inverter may be damaged.
	<p>Corrective measures</p> <p>Immediately disconnect the inverter from the electricity grid.</p> <ol style="list-style-type: none"> 1. Disconnect the miniature circuit-breaker. 2. Remove the Electronic Solar Switch. 3. Remove all DC connectors. 4. Check the DC voltage: <ul style="list-style-type: none"> - If the DC voltage is above the maximum input voltage, check the PV plant design or contact the PV array installer. - If the DC voltage is below the maximum input voltage, reconnect the inverter to the PV array as described in Section 5.4.4 "Connecting the PV Array (DC)" (page 31). <p>If the message occurs again, disconnect the inverter again and contact the SMA Service Line (see Section 13 "Contact" (page 80)).</p>
Watchdog	Internal program run disturbance.
Watchdog Srr	<p>Corrective measures</p> <ul style="list-style-type: none"> • Contact the SMA Service Line if this disturbance occurs frequently.

9.3 Red LED is Permanently Glowing

If the red status display LED is permanently glowing during operation, there is an earth fault in the PV array or at least one of the varistors for overvoltage protection is defective.

Procedure

1. Check for earth faults in the PV array as described in Section 9.3.1 "Checking the PV Array for Earth Faults" (page 64).
2. If the red LED continues to be glowing, check the varistors as described in Section 9.3.2 "Checking the Function of the Varistors" (page 66).

9.3.1 Checking the PV Array for Earth Faults

1. Disconnect the inverter from both the DC and AC sides as described in Section 7.2 "Opening the Inverter" (page 48).

DANGER!
Danger to life due to electric shock

- Only touch the insulation of the PV array cables.
- Do not connect strings with earth faults to the inverter.

NOTICE!
Excessive voltages can destroy the multimeter

- Only use multimeters with a DC input voltage range of up to at least 1,000 V.

2. Measure the voltages between the positive pole of each string and the earth potential (PE).

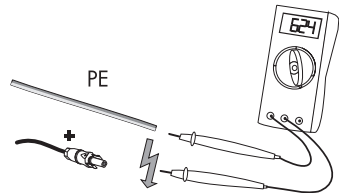

3. Measure the voltages between the negative pole of each string and the earth potential (PE).

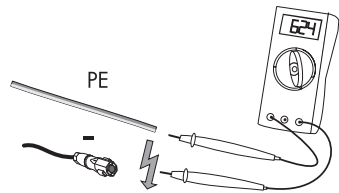

4. Measure the voltages between the positive and negative poles of each string.

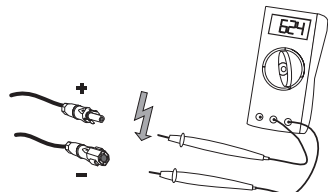

- An earth fault is present if the measured voltages are stable and the sum of the voltages of the positive pole against earth potential and the negative pole against earth potential of a string is approximately equal to the voltage between the positive and negative poles.

Result	Measure
<input checked="" type="checkbox"/> You have detected an earth fault .	<ul style="list-style-type: none"> The installer of the PV array must remedy the earth fault in the affected string. You can determine the location of the earth fault as described below. Do not reconnect the faulty string. Close and commission the inverter as described in Section 7.3 "Closing the Inverter" (page 51).
<input checked="" type="checkbox"/> You have not detected any earth fault .	It is likely that one of the thermally monitored varistors is defective. <ul style="list-style-type: none"> Check the varistors as described in Section 9.3.2 "Checking the Function of the Varistors" (page 66).

Location of the Earth Fault

The approximate position of the earth fault can be determined from the ratio of the measured voltages between the positive pole against earth potential (PE) and the negative pole against earth potential (PE).

Example:

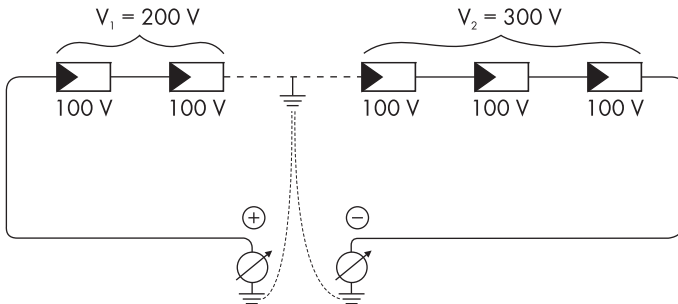

In this case, the earth fault is between the second and third PV modules.

- The earth fault check is now complete.

9.3.2 Checking the Function of the Varistors

Varistors are wear parts, whose functional efficiency diminishes with age or following repeated responses as a result of overvoltages. It is therefore possible that one of the thermally monitored varistors has lost its protective function, and thus the red LED is glowing.



Position of the varistors

You can determine the position of the varistors using the illustration below.

Note the following assignment of the terminals:

- Terminal A: outer terminal (varistor connection **with loop**)
- Terminal B: middle terminal
- Terminal C: outer terminal (varistor connection **without loop**)

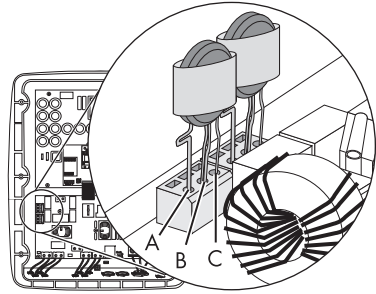

Check the function of the varistors as described below:

1. Open the inverter as described in Section 7.2 "Opening the Inverter" (page 48).
2. With the aid of a multimeter, determine for both varistors in the installed state whether a conductive connection exists between connectors B and C.

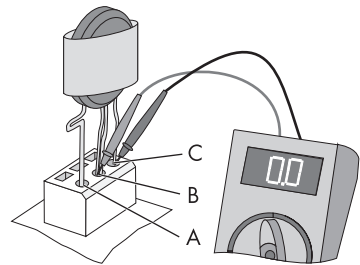

Result	Measure
<input checked="" type="checkbox"/> There is a conductive connection:	Presumably there is a different error in the inverter. <ul style="list-style-type: none"> • Contact the SMA Service Line (see Section 13 "Contact" (page 80)).

Result	Measure
<p><input checked="" type="checkbox"/> There is no conductive connection:</p>	<p>The respective varistor is defective and must be replaced. Varistor failure is generally due to influences that affect all varistors in a similar manner (temperature, age, induced overvoltage). SMA Solar Technology AG recommends that you replace both varistors.</p> <p>The varistors are specially manufactured for use in the inverter and are not commercially available. They must be ordered directly from SMA Solar Technology AG (see Section 12 "Accessories" (page 79)).</p> <ul style="list-style-type: none"> To replace the varistors, proceed to step 3.



NOTICE!

Destruction of the inverter due to overvoltage

If varistors are missing, the inverter is no longer protected against overvoltages.

- Replacement varistors should be obtained as soon as possible.
- Do not** operate the inverter without varistors in PV plants with a high risk of overvoltages.

3. Insert the insertion tool into the openings of the terminal contacts (1).

This releases the terminals.

If you have not received an insertion tool for operating the terminals with the replacement varistors, contact SMA Solar Technology AG. As an alternative, the individual terminal contacts can be operated using a screwdriver (blade width 3.5 mm).

4. Remove the varistor (2).

5. Insert the new varistor (3).

The pole with the small loop (crimp) must be fitted to terminal A when replacing the varistor.

6. Close the inverter as described in Section 7.3 "Closing the Inverter" (page 51).

The testing and replacement of the varistors is completed.

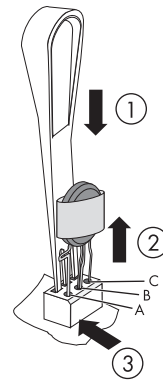

10 Decommissioning

10.1 Dismounting the Inverter

1. Open the inverter as described in Section 7.2 "Opening the Inverter" (page 48).
2. Remove all cables from the inverter.
3. Close the inverter using the six screws and the corresponding conical spring washers.

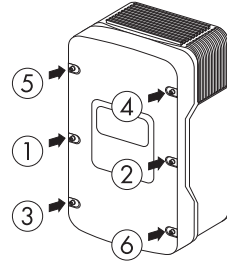

4. Remove the ventilation grids from both sides.

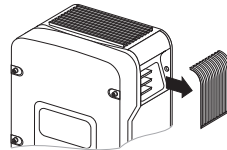

5. Remove the two screws on the left- and right-hand sides of the inverter that attach it to the wall mounting bracket.
6. Disconnect the anti-theft protection if applicable.

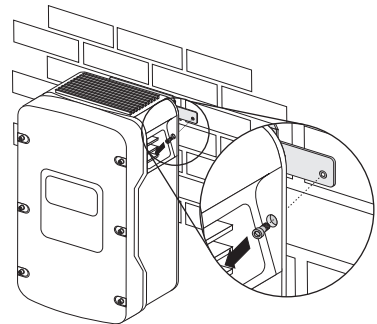

- Remove the inverter by lifting it up and out of the wall mounting bracket.

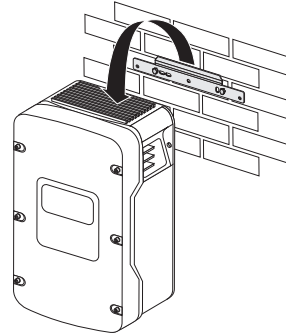

- Use the side handles (above and below) or a steel rod (maximum diameter 30 mm) to transport the inverter. The rod must be pushed through the enclosure openings.

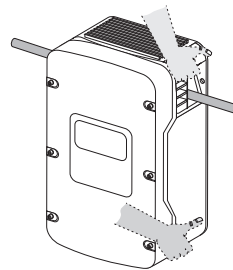

- The inverter is dismantled.

10.2 Packing the Inverter

If possible, always pack the inverter in its original packaging. If this is no longer available, you can also use an equivalent carton. The carton must be completely closeable, have a handle system and be designed to support both the weight and size of the inverter.

10.3 Storing the Inverter

Store the inverter in a dry place where ambient temperatures are always between -25°C and $+60^{\circ}\text{C}$.

10.4 Disposing of the Inverter

Dispose of the inverter at the end of its service life in accordance with the current locally applicable disposal regulations for electronic waste. Alternatively, send it back to SMA Solar Technology AG with shipping paid by sender, and labelled "FOR DISPOSAL" ("ZUR ENTSORGUNG") (contact see Page 80).

11 Technical Data

11.1 DC/AC

11.1.1 Sunny Mini Central 4600A

DC input

Maximum DC power at $\cos \varphi = 1$	5,250 W
Maximum input voltage*	600 V
MPP voltage range	246 V ... 480 V
Rated input voltage	246 V
Minimum input voltage	211 V
Start input voltage	300 V
Maximum input current	26 A
Maximum input current per string	26 A
Number of independent MPP inputs	1
Strings per MPP input	4

* The maximum open-circuit voltage that can occur at -10°C cell temperature must not exceed the maximum input voltage

AC Output

Rated power at 230 V, 50 Hz	4,600 W
Maximum apparent AC power*	5,000 VA
Rated grid voltage	230 V
AC nominal voltage	220 V / 230 V / 240 V
AC voltage range	160 V ... 265 V
Nominal AC current at 220 V	20.9 A
Nominal AC current at 230 V	20.0 A
Nominal AC current at 240 V	19.16 A
Maximum output current	26 A
Total harmonic factor of the output current with AC voltage < 2% and AC power > 50% of the rated power	≤ 3%
Rated mains frequency	50 Hz
AC mains frequency	50 Hz/60 Hz
Operating range at AC mains frequency of 50 Hz	44 Hz ... 55 Hz
Operating range at AC mains frequency of 60 Hz	54 Hz ... 65 Hz
Displacement power factor, adjustable**	0.8 _{overexcited} ... 0.8 _{underexcited}
Power factor at nominal AC power***	1
Feed-in phases	1
Connection phases	1
Overvoltage category according to IEC 60664-1	III

* 4,600 VA with VDE-AR-N-4105

** Applies to SMC 4600A-1 I

*** Applies to SMC 4600A

Efficiency

Maximum efficiency, η_{\max}	96.1%
European weighted efficiency, η_{EU}	95.3%

11.1.2 Sunny Mini Central 5000A

DC input

Maximum DC power at $\cos \varphi = 1$	5,750 W
Maximum input voltage*	600 V
MPP voltage range	246 V ... 480 V
Rated input voltage	246 V
Minimum input voltage	211 V
Start input voltage	300 V
Maximum input current	26 A
Maximum input current per string	26 A
Number of independent MPP inputs	1
Strings per MPP input	4

* The maximum open-circuit voltage that can occur at a cell temperature of -10°C must not exceed the maximum input voltage.

AC Output

Rated power at 230 V, 50 Hz	5,000 W
Maximum apparent AC power	5,500 VA
Rated grid voltage	230 V
AC nominal voltage	220 V / 230 V / 240 V
AC voltage range	160 V ... 265 V
Nominal AC current at 220 V	22.7 A
Nominal AC current at 230 V	21.7 A
Nominal AC current at 240 V	20.8 A
Maximum output current	26 A
Total harmonic factor of the output current with AC voltage < 2% and AC power > 50% of the rated power	≤ 3%
Rated mains frequency	50 Hz
AC mains frequency	50 Hz/60 Hz
Operating range at AC mains frequency of 50 Hz	44 Hz ... 55 Hz
Operating range at AC mains frequency of 60 Hz	54 Hz ... 65 Hz
Displacement power factor, adjustable*	0.8 _{overexcited} ... 0.8 _{underexcited}
Power factor at nominal AC power**	1
Feed-in phases	1
Connection phases	1
Overvoltage category according to IEC 60664-1	III

* Applies to SMC 5000A-11

** Applies to SMC 5000A

Efficiency

Maximum efficiency, η_{\max}	96.1%
European weighted efficiency, η_{EU}	95.3%

11.1.3 Sunny Mini Central 6000A

DC input

Maximum DC power at $\cos \varphi = 1$	6,300 W
Maximum input voltage*	600 V
MPP voltage range	246 V ... 480 V
Rated input voltage	246 V
Minimum input voltage	211 V
Start input voltage	300 V
Maximum input current	26 A
Maximum input current per string	26 A
Number of independent MPP inputs	1
Strings per MPP input	4

* The maximum open-circuit voltage that can occur with -10°C cell temperature must not exceed the maximum input voltage.

AC Output

Rated power at 230 V, 50 Hz	6,000 W
Maximum apparent AC power	6,000 VA
Rated grid voltage	230 V
AC nominal voltage	220 V / 230 V / 240 V
AC voltage range	160 V ... 265 V
Nominal AC current at 230 V	26 A
Nominal AC current at 240 V	25 A
Maximum output current	26 A
Total harmonic factor of the output current with AC voltage < 2% and AC power > 50% of the rated power	≤ 3%
Rated mains frequency	50 Hz
AC mains frequency	50 Hz/60 Hz
Operating range at AC mains frequency of 50 Hz	44 Hz ... 55 Hz
Operating range at AC mains frequency of 60 Hz	54 Hz ... 65 Hz
Displacement power factor, adjustable*	0.8 _{overexcited} ... 0.8 _{underexcited}
Power factor at nominal AC power**	1
Feed-in phases	1
Connection phases	1
Overvoltage category according to IEC 60664-1	III

* Applies to SMC 6000A-1 I

** Applies to SMC 6000A

Efficiency

Maximum efficiency, η_{\max}	96.1%
European weighted efficiency, η_{EU}	95.3%

11.2 General Data

Width x height x depth with Electronic Solar Switch	468 mm x 613 mm x 242 mm
Weight	63 kg
Length x width x height of packaging	396 mm x 803 mm x 596 mm
Transport weight	68 kg
Climatic class as per IEC 60721-2-1	4K4H
Operating temperature range	- 25°C ... +60°C
Maximum permissible value for relative humidity, non-condensing	100%
Maximum operating altitude above MSL	2,000 m
Noise emission (typical)	≤ 42 dB(A)
Power loss in night operation	0.25 W
Topology	LF transformer
Cooling concept	OptiCool
Fan connection	designed as safe disconnection in accordance with DIN EN 50178:1998-04
Degree of protection for electronics according to IEC 60529	IP65
Protection class according to IEC 62103	I

11.3 Protective Devices

DC reverse polarity protection	short-circuit diode
Input-side disconnection device	Electronic Solar Switch
DC overvoltage protection	thermally monitored varistors
AC short-circuit current capability	current control
Grid monitoring	SMA Grid Guard 2.1
Maximum permissible fuse protection	40 A
Earth fault monitoring	Insulation monitoring: $R_{iso} > 1 \text{ M}\Omega$
Galvanic isolation	available

11.4 Approvals

Country standard, as of 07/2012	SMC 4600A-11	SMC 5000A-11	SMC 6000A-11	SMC 4600A	SMC 5000A	SMC 6000A
VDE0126-1-1	✓	✓	✓	✓	✓	✓
VDE-AR-N-4105	✓	✓	✓	-	-	-
AS 4777	○	○	○	-	✓	✓
C10/11	✓	✓	✓	-	-	-
PPDS	✓	✓	✓	✓	✓	✓
GBT19939-2005	✓	✓	✓	✓	✓	✓
VDE0126-1-1/ UTE C15-712-1	✓	✓	✓	✓	✓	✓
UTE C15-712-1/ EDF SEI req.	✓	✓	✓	✓	✓	✓
PPC	✓	✓	✓	✓	✓	✓
SI 4777	○	○	○	✓	✓	✓
CEI 0-21	-	-	✓	-	-	-
EN 50438*	✓	✓	✓	✓	✓	✓
RD 1699	✓	✓	✓	-	-	-
RD 661/2007	✓	✓	✓	✓	✓	✓
IEC 61727 PEA	-	-	-	-	✓	✓
G83/1-1	-	-	-	✓	✓	✓
G59/2	✓	✓	✓	-	-	-

* EN 50438: not applicable to all deviations from the national standard

○ In planning stage

11.5 Climatic Conditions

According to IEC 60721-3-4, Installation type C, Class 4K4H

Extended temperature range	- 25°C ... +60°C
Extended humidity range	0% ... 100%
Extended air pressure range	79.5 kPa ... 106 kPa

According to IEC 60721-3-4, Transport type E, Class 2K3

Temperature range	- 25°C ... +70°C
-------------------	------------------

11.6 Features

DC connection	SUNCLIX DC connector
AC connection	Screw terminal
Display	LC text display
Bluetooth® Wireless Technology	optional
RS485, galvanically isolated	optional

11.7 Electronic Solar Switch (ESS)

Electrical endurance in the event of short circuit, at nominal current 35 A	at least 50 switching processes
Maximum switching current	35 A
Maximum switching voltage	800 V
Maximum PV power	12 kW
Degree of protection when plugged in	IP65
Degree of protection when not plugged in	IP21

11.8 Torques

Enclosure lid screws	6.0 Nm
Additional earth terminal	6.0 Nm
Cheese-head screw for attaching the enclosure to the wall mounting bracket	6.0 Nm
SUNCLIX swivel nut	2.0 Nm
Screw terminal AC connection	2.5 Nm
RS485 communication connection	1.5 Nm

11.9 Earthing Systems

IT system	suitable
TN-C system	suitable
TN-S system	suitable
TN-C-S system	suitable
TT system	suitable
Split phase	suitable

12 Accessories

You will find the corresponding accessories and spare parts for your product in the following overview. If required, you can order these from SMA Solar Technology AG or your specialist dealer.

Description	Brief description	SMA order number
Bluetooth retrofit kit	Bluetooth communication interface	BTPBINV-NR
Insertion tool for replacement of varistors	Insertion tool for varistors	SB-TVWZ
Electronic Solar Switch	ESS handle (spare)	ESS-HANDLE:04 Also indicate the inverter serial number.
Negative earthing set	Retrofit kit for the negative earthing of the DC input	ESHV-N-NR
Positive earthing set	Retrofit kit for the positive earthing of the DC input	ESHV-P-NR
Replacement varistors	Set of thermally monitored varistors (2) incl. insertion tool	SB-TV4
Radio retrofit kit	Radio Piggy-Back for retrofitting an inverter for communication with Sunny Beam, including antenna, coaxial cable, and PG cable gland (metal)	BEAMPB-NR
Ventilation grid	Ventilation grid set "right and left" as spare parts	45-7202
Power Balancer plug	Retrofit kit for retrofitting a Sunny Mini Central equipped with an SMA Power Balancer to the SMA Power Balancer plug-in system	PBL-SMC-10-NR
RS485 retrofit kit	RS485 interface	485PB-SMC-NR
SMA Power Balancer Y-cable	Connecting cable (2 x 2 m) for SMA Power Balancer plug-in system	PBL-YCABLE-10
SUNCLIX DC connector	Field plug for conductor cross-sections of 2.5 mm ² ... 6 mm ²	SUNCLIX-FC6-SET

13 Contact

If you have technical problems concerning our products, please contact the SMA Service Line. We require the following information in order to provide you with the necessary assistance:

- Inverter type
- Inverter serial number
- Type and number of the PV modules connected
- Optional equipment, e.g. communication products
- Blink code or inverter display message

SMA Solar Technology AG

Sonnenallee 1

34266 Niestetal, Germany

www.SMA.de

SMA Service Line

Inverters +49 561 9522 1499

Communication: +49 561 9522 2499

Fax: +49 561 9522 4699

E-Mail: ServiceLine@SMA.de

Legal Provisions

The information contained in this document is the property of SMA Solar Technology AG. Publishing its content, either partially or in full, requires the written permission of SMA Solar Technology AG. Any internal company copying of the document for the purposes of evaluating the product or its correct implementation is allowed and does not require permission.

SMA Factory Warranty

The current warranty conditions come enclosed with your device. These are also available online at www.SMA-Solar.com and can be downloaded and are available on paper from the usual sales channels if required.

Trademarks

All trademarks are recognized even if these are not marked separately. Missing designations do not mean that a product or brand is not a registered trademark.

The *Bluetooth*[®] word mark and logos are registered trademarks owned by Bluetooth SIG, Inc. and any use of such marks by SMA Solar Technology AG is under licence.

QR Code[®] is a registered trademark of DENSO WAVE INCORPORATED.

SMA Solar Technology AG

Sonnenallee 1
34266 Niestetal
Germany

Tel. +49 561 9522-0
Fax +49 561 9522-100
www.SMA.de
E-Mail: info@SMA.de

© 2004 to 2012 SMA Solar Technology AG. All rights reserved

SMA Solar Technology

www.SMA-Solar.com

SMA Solar Technology AG

www.SMA.de

SMA Australia Pty. Ltd.

www.SMA-Australia.com.au

SMA Benelux bvba/sprl

www.SMA-Benelux.com

SMA Beijing Commercial Company Ltd.

www.SMA-China.com.cn

SMA Central & Eastern Europe s.r.o.

www.SMA-Czech.com

SMA France S.A.S.

www.SMA-France.com

SMA Hellas AE

www.SMA-Hellas.com

SMA Ibérica Tecnología Solar, S.L.U.

www.SMA-Iberica.com

SMA Solar India Pvt. Ltd.

www.SMA-India.com

SMA Italia S.r.l.

www.SMA-Italia.com

SMA Japan K.K.

www.SMA-Japan.com

SMA Technology Korea Co., Ltd.

www.SMA-Korea.com

SMA Middle East LLC

www.SMA-Me.com

SMA Portugal - Niestetal Services Unipessoal Lda

www.SMA-Portugal.com

SMA Solar (Thailand) Co., Ltd.

www.SMA-Thailand.com

SMA Solar UK Ltd.

www.SMA-UK.com

